



أنظمة خزائن فينوليك

تم تصميم وتصنيع أنظمة خزائن فينوليك التي تتميز بالحدائثة والمرونة لتأمين نظام الخزائن الشخصية. لتناسب جميع الاحتياجات المتنوعة. كما أنها تتوفر بتصاميم ومقاسات مختلفة تتراوح بين الخزائن الطويلة الى الخزائن المتعددة مما يؤمن تخزين لعدد يصل الى ستة أشخاص.

The "ALS" Phenolic Locker versatile and flexible range has been designed and manufactured as a multipurpose personal storage system for a wide range of application. Available in various design and sizes ranging from full length units to multi-compartment units offering security storage up to 6 people.



Paper Towel Dispenser



T600

T402

T400



T610

T210

P203 Recessed Paper Towel Dispenser

Same as P210

Capacity: 350 C-Fold or 475 M-Fold Size: 11 3/4"W x 15 3/4"H x 4 1/4"D

P210 Recessed Paper Towel Dispenser

Material: Stainless Steel gauge 22

Capacity: 600 C-Fold or 800 M-Fold Size: 11 1/2"W x 26 1/2 "H x 4 1/4"D

P211 Surface Mounted Paper Towel Dispenser

Same as P210 , but surface mounted.

P400 Surface Mounted Paper Towel Dispenser

Material: Stainless Steel type 304 gauge 22

Capacity: 400 C-Fold or 25 M-Fold Size: 11"W x 14 1/2"H x 4"D

P401 Surface Mounted Paper Towel Dispenser

Same as P400

Capacity: 200 C-Fold or 325 M-Fold Size: 11"W x 8"H x 4"D

P402 Surface Mounted Paper Towel Dispenser

Material: Stainless Steel gauge 22

Capacity: 200 C-Fold or 275 M-Fold Size: 11 1/4"W x 6 1/4"H x 4"D

P600 Recessed Facial Tissue Dispenser

Material: Stainless Steel with Galv. Steel Housing

Capacity: 300 Single Ply or 150 Double Ply Size: 10 1/2"W x 5 1/4"H x 2 1/2"D

P610 Surface Mounted Facial Tissue Dispenser

Material: Stainless Steel with Galv. Steel Housing gauge 22

Capacity: 300 Single Ply or 150 Double Ply Size: 10 3/4"W x 5 3/4"H x 2 1/4"D

Soap Dispenser



S400

S101

S200



S500

S101 Recessed Soap Dispenser (Horizontal)

Type: Liquid Soap Capacity: 56 ounces Size: 10"W x 6"H x 4 1/4" Dia.

S200 Surface Mounted Soap Dispenser (Vertical)

Type: Liquid Soap Capacity: 40 ounces

Type: Liquid Soap Capacity: 16 ounces Spout: 4" or 6"

S201 Surface Mounted Soap Dispenser (Horizontal)

Same as S200, but horizontal

Type: Liquid Soap Capacity: 40 ounces

S400 Surface Mounted Soap Dispenser

Type: Liquid Soap Capacity: 16 ounces

S401 Surface Mounted Soap Dispenser (Vertical)

Type: Powder Soap Capacity: 32 ounces

S500 Basin/Lavatory Mounted Soap Dispenser

Type: Liquid Soap Capacity: 32 ounces Spout: 4" or 6"

Type: Liquid Soap Capacity: 24 ounces

Hand Dryer



D602

D801



D203

D203 Surface Mounted Auto Hair Dryer

Speed: 2 Speed Voltage: 220V

Heater: 800W Size: 8"W x 11 1/2"H x 4"D

D601 Push Button Hand Dryer

Stainless Steel gauge 18 Voltage: 220V

Heater: 2100W Size: 12 3/4"W x 10"H x 9 1/4"D

D602 Auto Sensor Hand Dryer

Same as D601 , but auto sensor.

D801 Push Button Hand Dryer

Material: Die Cast Voltage: 220V

Heater: 2100W Size 12 3/4"W x 10"H x 9 1/4"D

D802 Auto Sensor Hand Dryer

Same as D801 , but auto sensor

Combination Paper Towel Dispenser

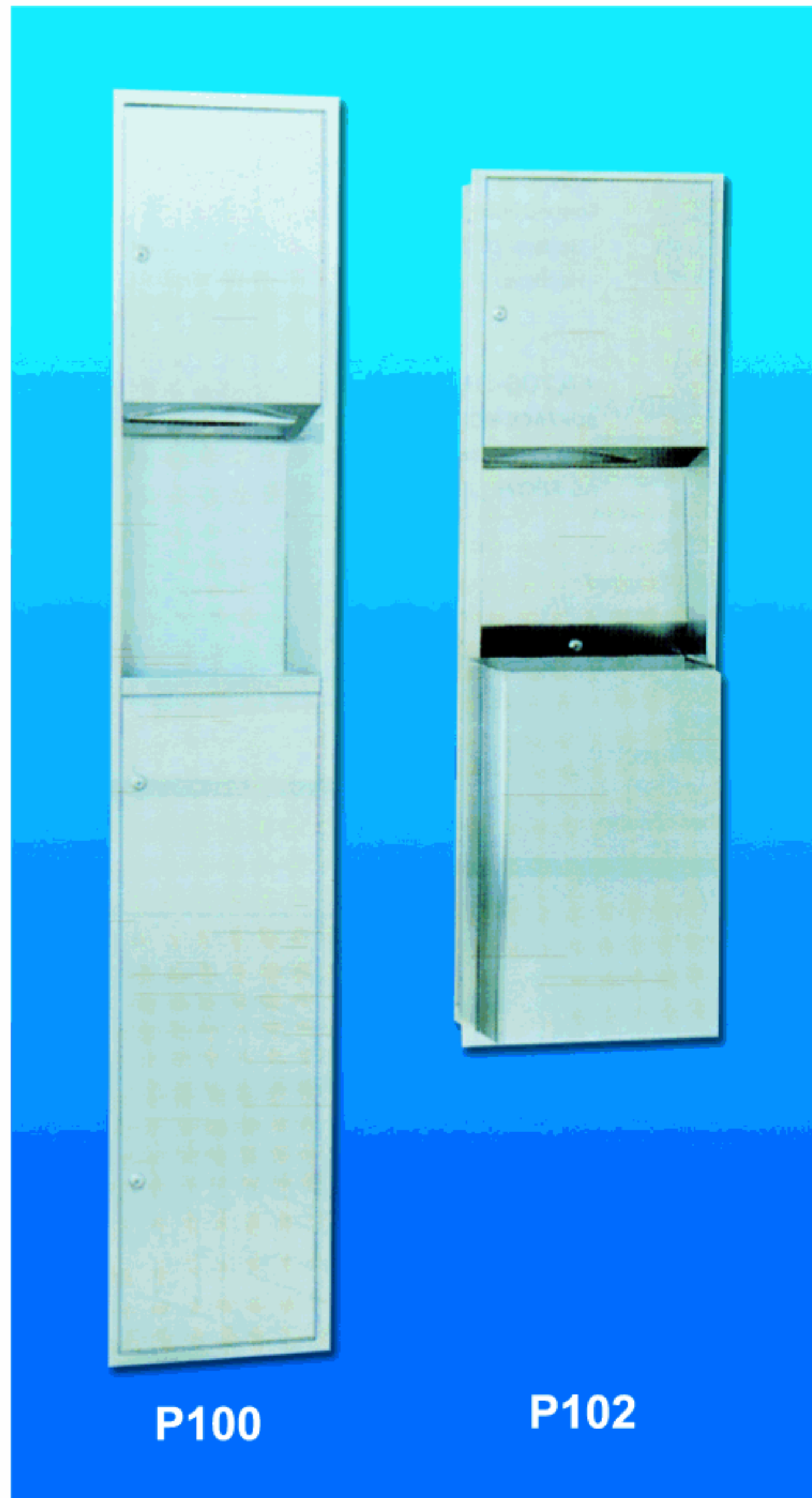

P100

P102



W900

W202

W210

P100 Recessed Paper Towel Dispenser & Waste Receptacle

Material: Stainless Steel type 304 gauge 22

Capacity: 600 C-Fold 800 M-Fold or 1200 S-Fold

Waste Capacity: 10.5 Gal. Wall Opening Size: 12 3/4"W x 72 1/2"H x 6 1/4"D

P101 Recessed Paper Towel Dispenser & Waste Receptacle

Same as P100, but the Capacity: 600 C-Fold or 800 M-Fold

Waste Capacity: 4.5 Gal. Size: 12 3/4 x 53 1/2"H x 4 3/4"H

P102 Recessed Paper Towel Dispenser & Extended Waste Receptacle

Material: Stainless Steel type 304 gauge 22 Capacity: 600 C-Fold or 800 M-Fold

Waste Capacity: 13 Gal. Size: 15 3/4"W x 54 1/2"W x 4 1/4"D

W200 Waster Receptacle

Same as W202

Size: 10 3/4"W x 9"H x 4 3/4"D Capacity: 2 Gal.

W201 Waste Receptacle

Same as W202

Size: 14"W x 11"H x 6"D Capacity: 6 Gal.

W202 Waste Receptacle

Material: Stainless Steel type 304 gauge 22

Size: 15"W x 20"H x 9"D Capacity: 12 Gal.

W203 Waste Receptacle

Same as W202

Size: 15 3/4"W x 21 3/4"H x 11 3/4"D Capacity: 18 Gal.

W210 Corner Waste Receptacle

Material: Stainless Steel type 304 gauge 22

Size: 10 1/4"W x 16"H x 10"D Capacity: 5 Gal.

W900 Flip Top Ashtray

Material: Stainless Steel type 304 gauge 22

Size: 4 1/2"W x 1 1/2"H x 3 3/4"D

Toilet Paper Dispenser



T201

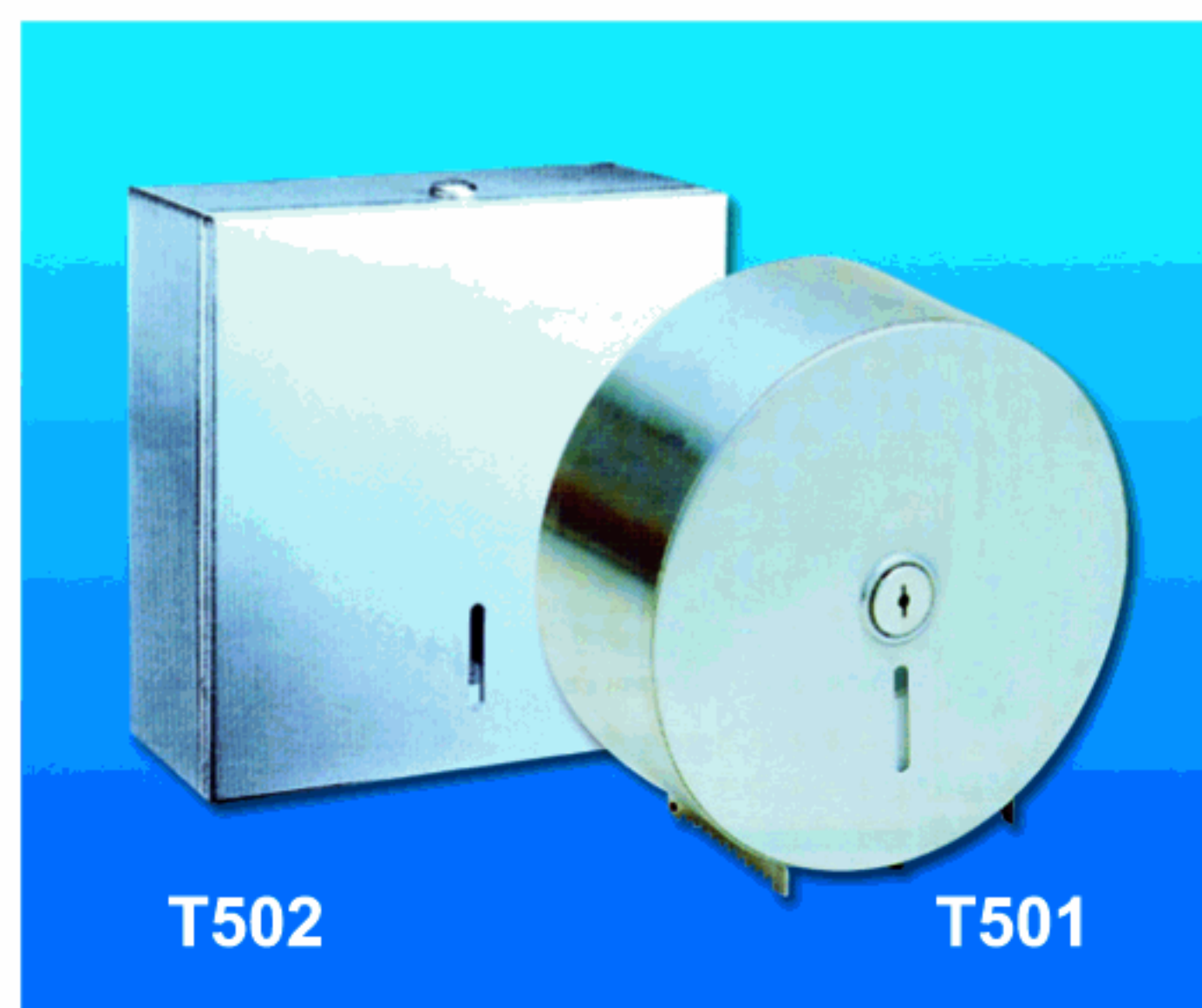

T502

T501



T211



T700



T230

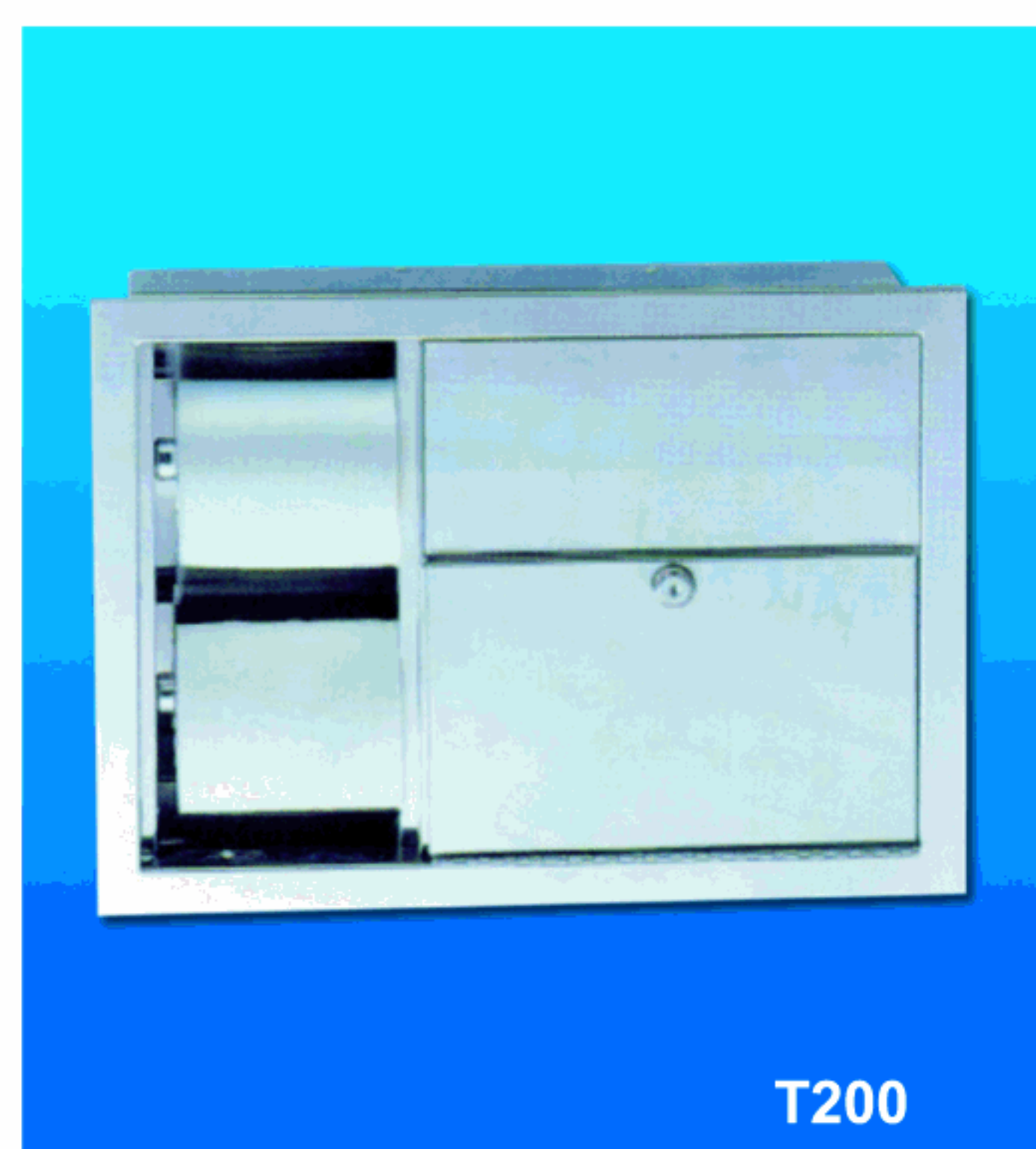

T200

T200 Recessed Toilet Tissue Dispenser & Disposal

Material: Stainless Steel type 304 gauge 22

Capacity: 2 Standard Roll Waste Capacity: 0.6 Gal.

Size: 16"W x 29 1/4"H x 4 1/4"D

T201 Surface Mounted Dual Roll Toilet Paper Dispenser

Material: Stainless Steel type 304 gauge 22

Capacity: 2 Roll of 5 1/4"Dia Size: 6"W x 12"H x 6 1/2"D

T202 Recessed Dual Roll Toilet Paper Dispenser

Material: Stainless Steel type 302 gauge 22

Capacity: 2 Roll of 5 1/4"Dia Size: 6"W x 12"H x 6 1/2"D

T210 Dual Access Toilet Paper Dispenser & Disposal

Material: Stainless Steel type 304 gauge 22

Capacity: 4 Standard Roll Waste Capacity: 1.3 Gal.

Size: 15 3/4"W x 18 1/8"H x 4"D

T211 Dual Access Partition Mounted Dual Roll Toilet Paper Dispenser w/ Ashtray

Material: Stainless Steel type 304 gauge 22

Capacity: 2 Roll of 5 1/4"Dia Size: 11 7/8"W x 12 1/4"H x 12 1/4"D

T220 Surface Mounted Dual Roll Toilet Paper Dispenser w/ Flip top Ashtray

Material: Stainless Steel type 304 gauge 22

Capacity: 2 Roll of 5 1/4"D Size: 6"W x 12"H x 6 1/2"D

T230 Recessed Toilet Seat Covers & Toilet Tissue Paper Dispenser w/ Waster Receptacle

Material: Stainless Steel type 304 gauge 22

Capacity: 2 standard Roll and 1000 Seat Cover

Size: 16"W x 29 1/4"H x 4 1/4"D

T501 Surface Mounted Commercial Roll Toilet Tissue Dispenser (Round)

Material: Stainless Steel type 304 gauge 22

Capacity: 6" Roll Size: 10 3/4"Dia x 4 3/4"D

T502 Surface Mounted Commercial Roll Toilet Tissue Dispenser (Square)

Material: Stainless Steel type 304 gauge 22

Capacity: 6" Roll Size: 10 3/4"W x 11"H x 4 3/4"D

T700 Recessed Toilet Seat Cover Dispenser

Material: Stainless Steel type 304 gauge 22

Capacity: 500 Seat Cover Paper

Size: 15 3/4"W x 11 1/4"H x 2 3/4"D

Grab Bars

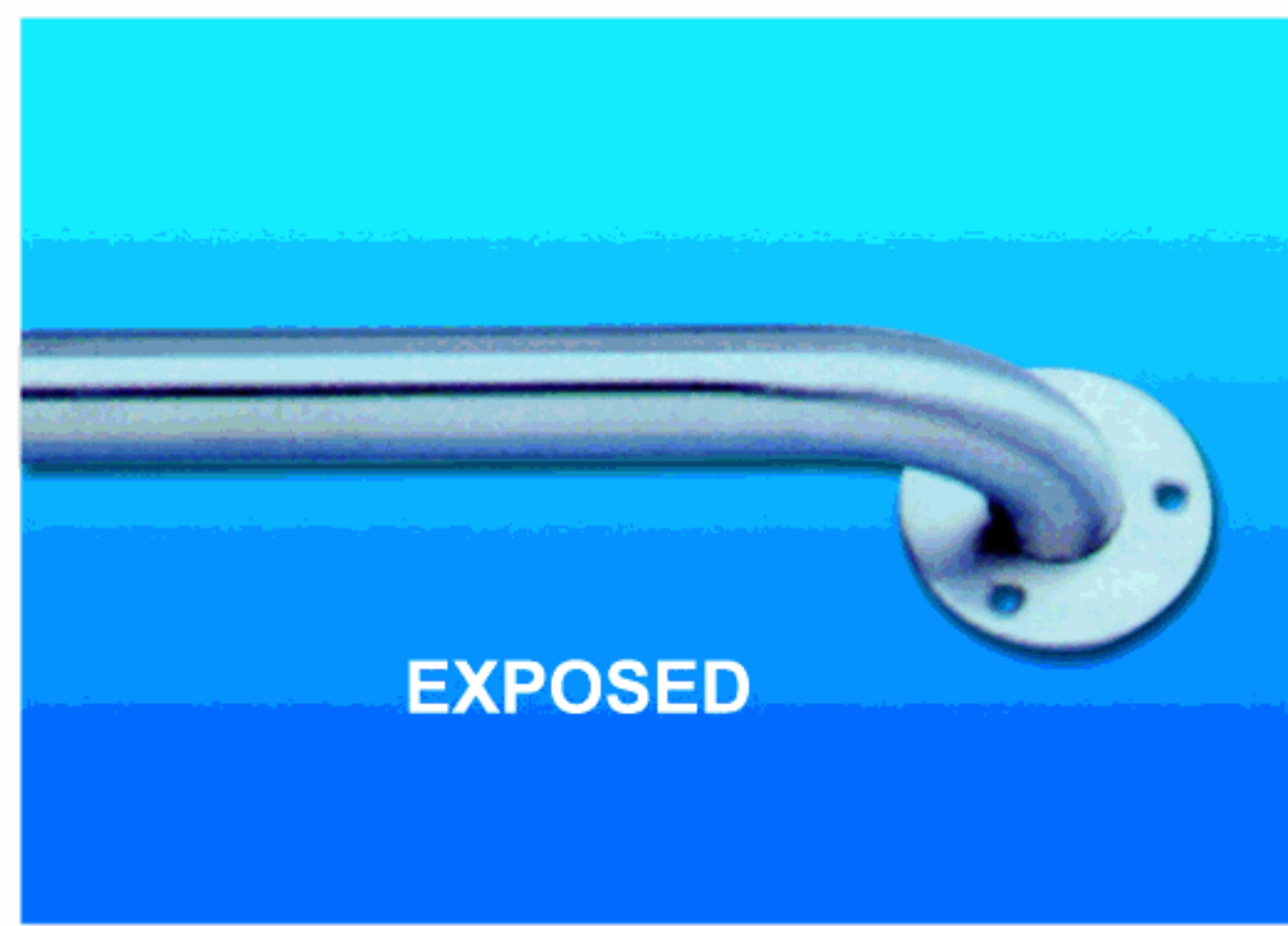
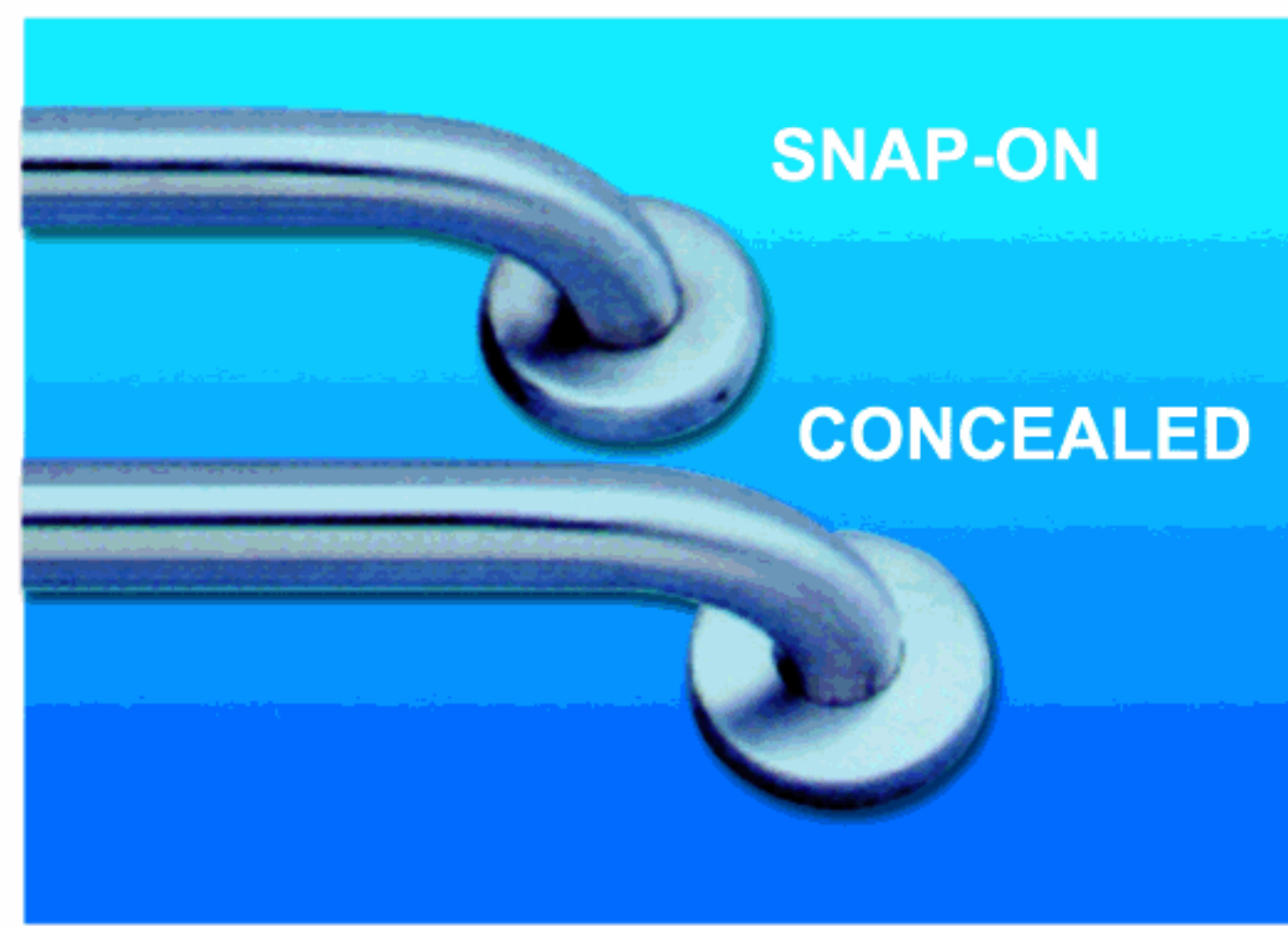

G Series Grab Bars

Tubing to be #18 gauge, type 304, stainless steel. Flanges of matching stainless to be heliarc welded to tubing to form a "One Piece" single structural unit. Bends are made by use of an automatic mandrel bender. All intermediate joints and supports are contour cut and heliarc welded.
Diameter: Available in 1", 1 1/4" or 1 1/2" diameter.

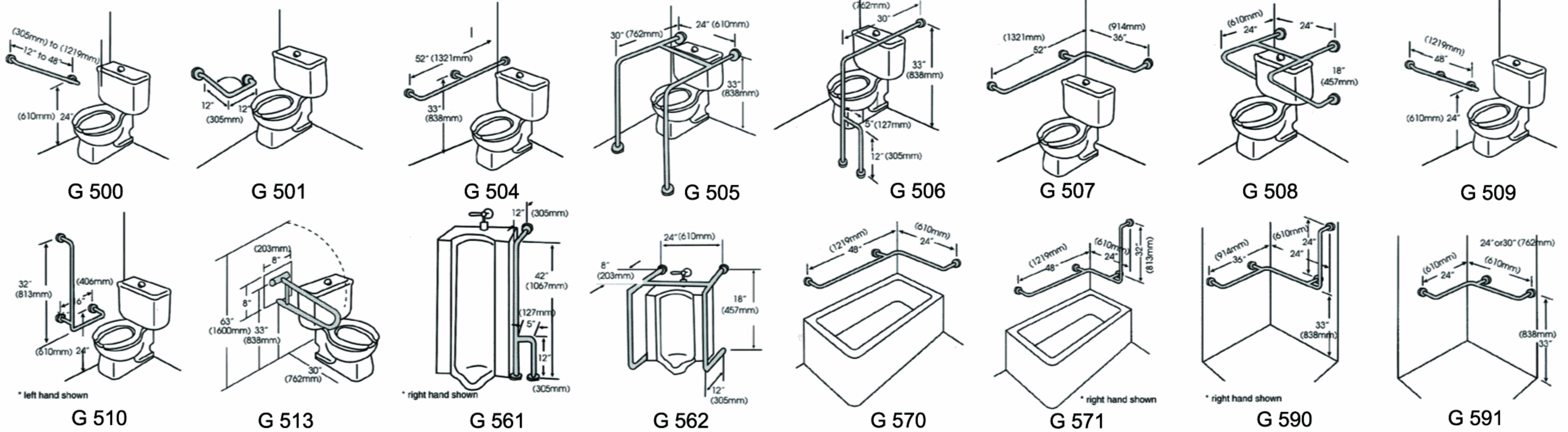

Other Accessories

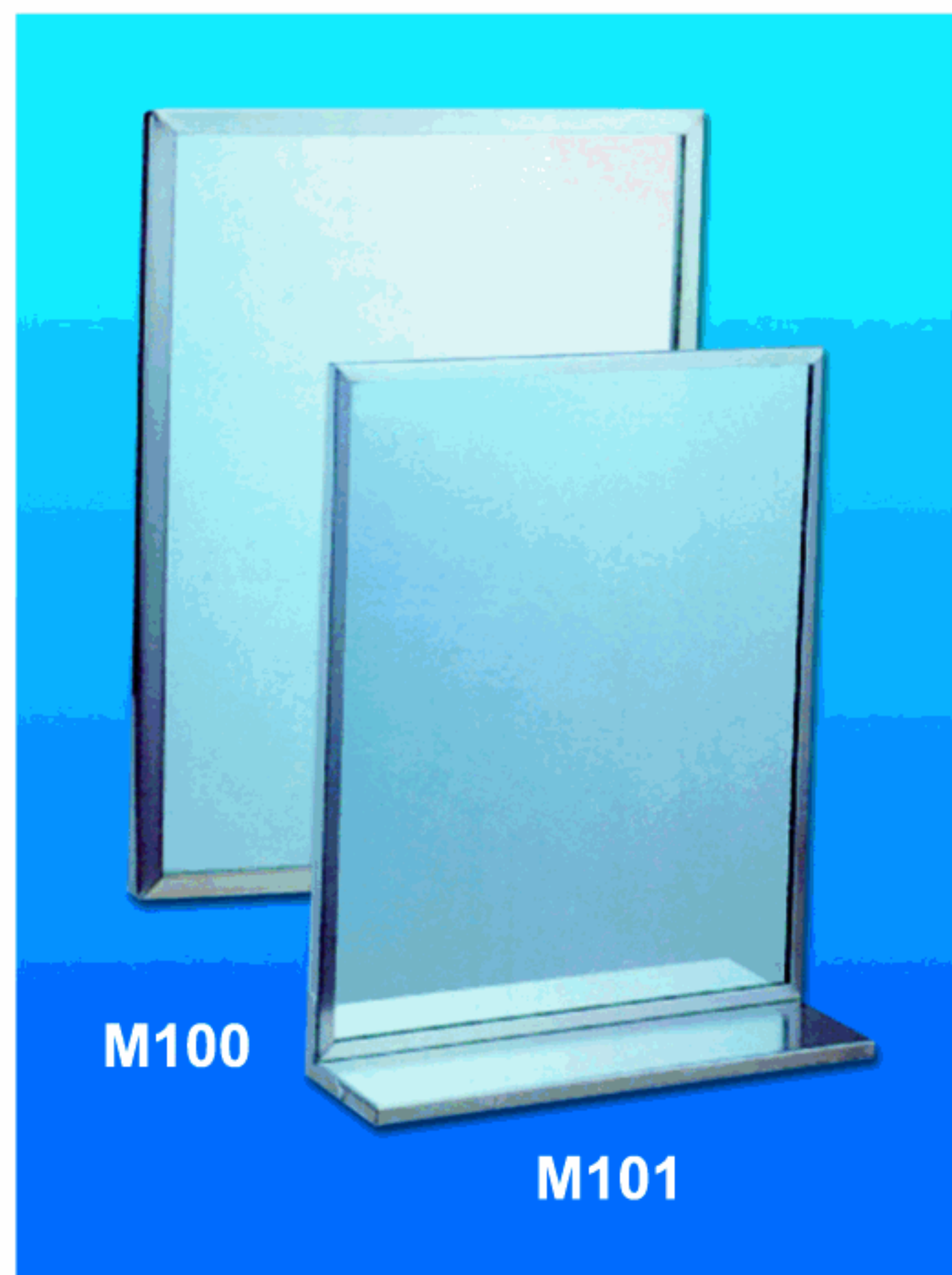

M100 Angle Frame Mirror

Material: Stainless Steel type 304 gauge 20
Standard Size: Special Size: Up to 72" in Width and up to 36" in Height
Fixing: Concealed

M101 Angle Frame Mirror with 5" Deep Shelf

Same as M100, but with 5" Deep Shelf

P300 Recessed Paper Towel Dispenser, Liquid Soap Dispenser, Recessed Shelf & Mirrored Door

Material: Stainless Steel type 304 gauge 22
Capacity 600 C-Fold or 800 M-Fold Soap Capacity 100 ounces
Size: 15 3/4"W 29"H x 4 1/4"D

Toilet Tissue Holder



T311 Surface Mounted Single Roll Toilet Tissue Dispenser

Material: Die Cast Aluminum

T312 Same as T311, but double

T321 Surface Mounted Single Roll Toilet Tissue Dispenser

Material: Steel Chrome Plated

T322 Same as T321, but double

T331 Surface Mounted Single Roll Toilet Tissue Dispenser

Material: Zinc Die Cast Chrome Plated

T332 Same as T331, but double

T382 Stainless Steel Shelf & Double Toilet Paper Holder w/ Hoods

Material: Stainless Steel type 304 gauge 18

T381 Same as T382, but single

T362 Stainless Steel Shelf & Double Toilet Paper Holder w/ Hoods & Ashtray

Material: Stainless Steel type 304 gauge 18

T361 Same as T362, but single

Stainless Steel Bath Accessories

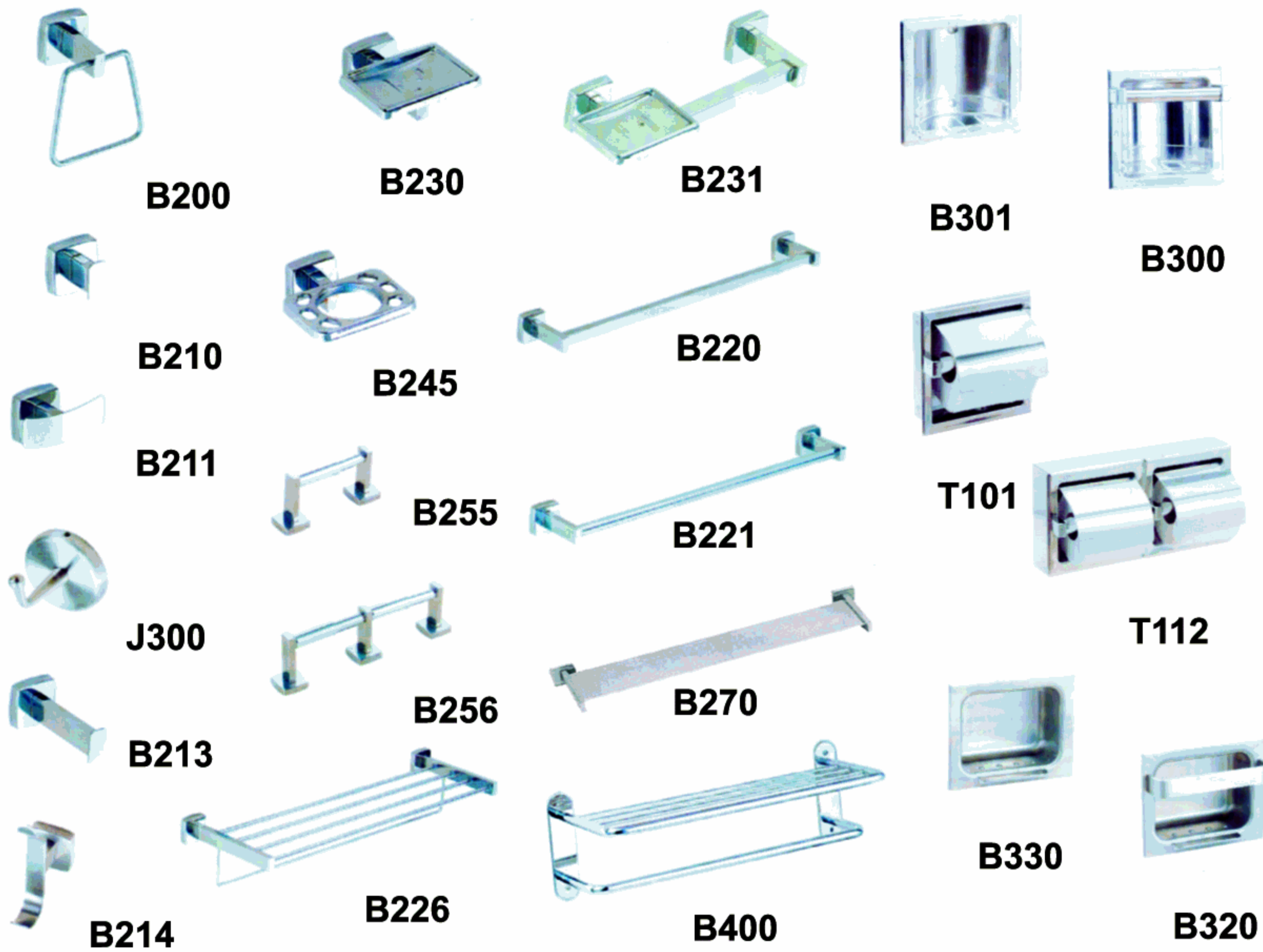

- B200 - Towel Ring
- B210 - Single Robe Hook
- B211 - Double Robe Hook
- B213 - Towel Pin
- B214 - Hat & Coat Hook
- B220 - Square Towel Bar (18", 24", 34", 36") 3/4"
- B221 - Round Towel Bar (18", 24", 30", 36") 3/4" Diameter
- B226 - Towel Shelf with Drying Rod 18", 24"
- B230 - Soap Dish with Drain
- B231 - Horizontal Soap Dish & Bar
- B245 - Toothbrush & Tumbler Holder
- B255 - Single Roll Toilet Paper Dispenser
- B256 - Double Roll Toilet Paper Dispenser
- B270 - Towel Shelf
- B300 - Recessed Soap Dish with Bar
- B301 - Recessed Soap Dish
- B320 - Recessed Heavy Duty Soap Dish Bar
- B330 - Recessed Heavy Duty Soap Dish
- B400 - Heavy Duty Towel Shelf with Drying Rod (18", 20", 24", 30")
- J300 - Heavy Duty Robe Hook
- T101 - Recessed Toilet Tissue Holder w/ Hood
- T102 - Recessed Toilet Tissue Holder
- T112 - Recessed Double Roll Toilet Paper Dispenser w/ Hood

Special Accessories

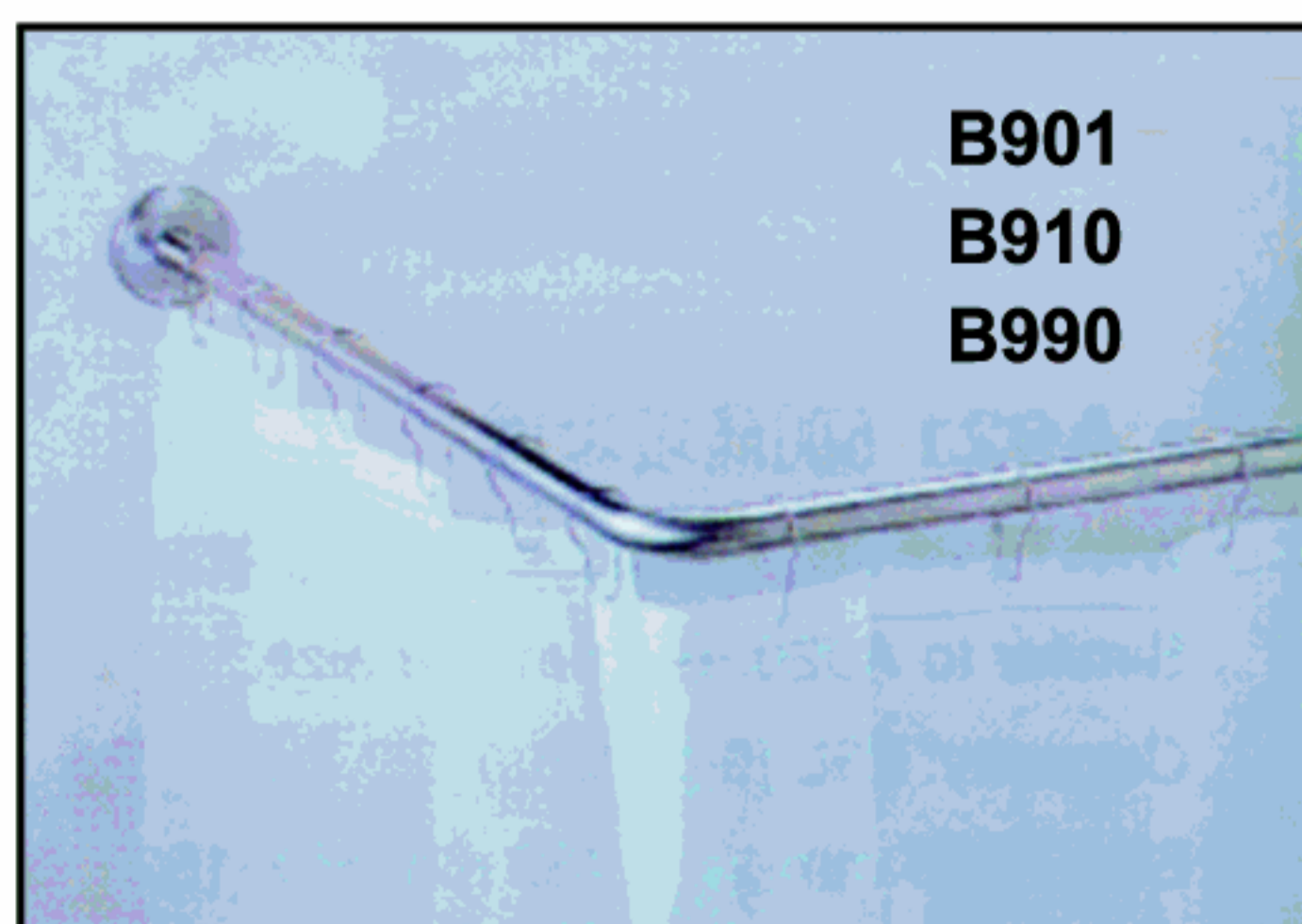
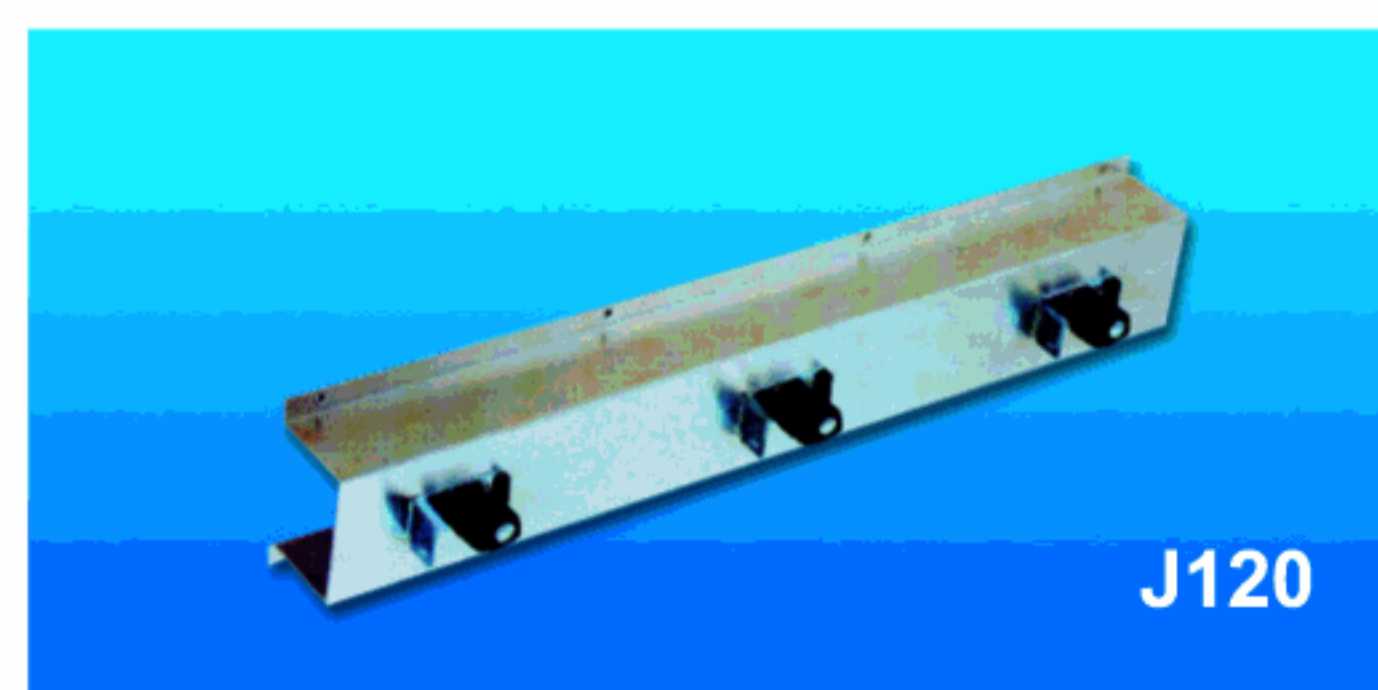
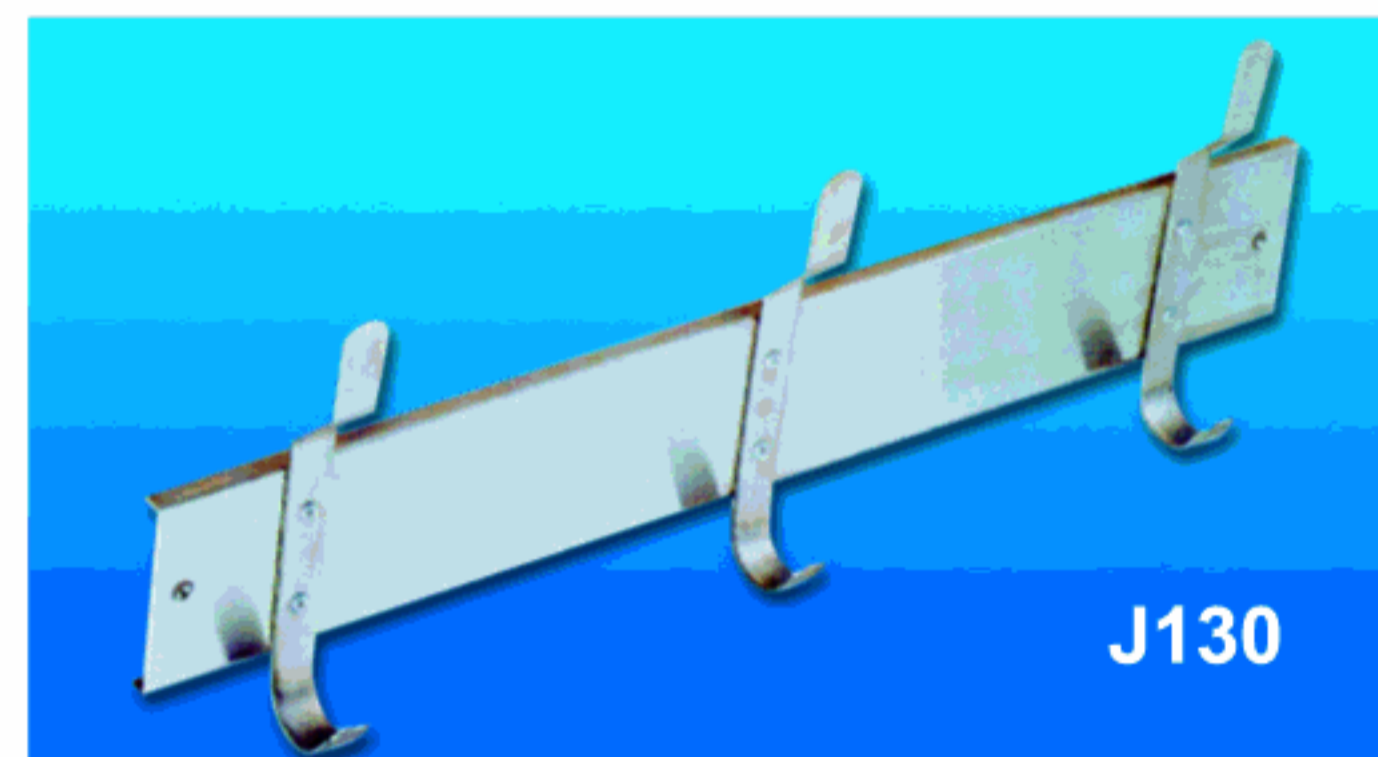
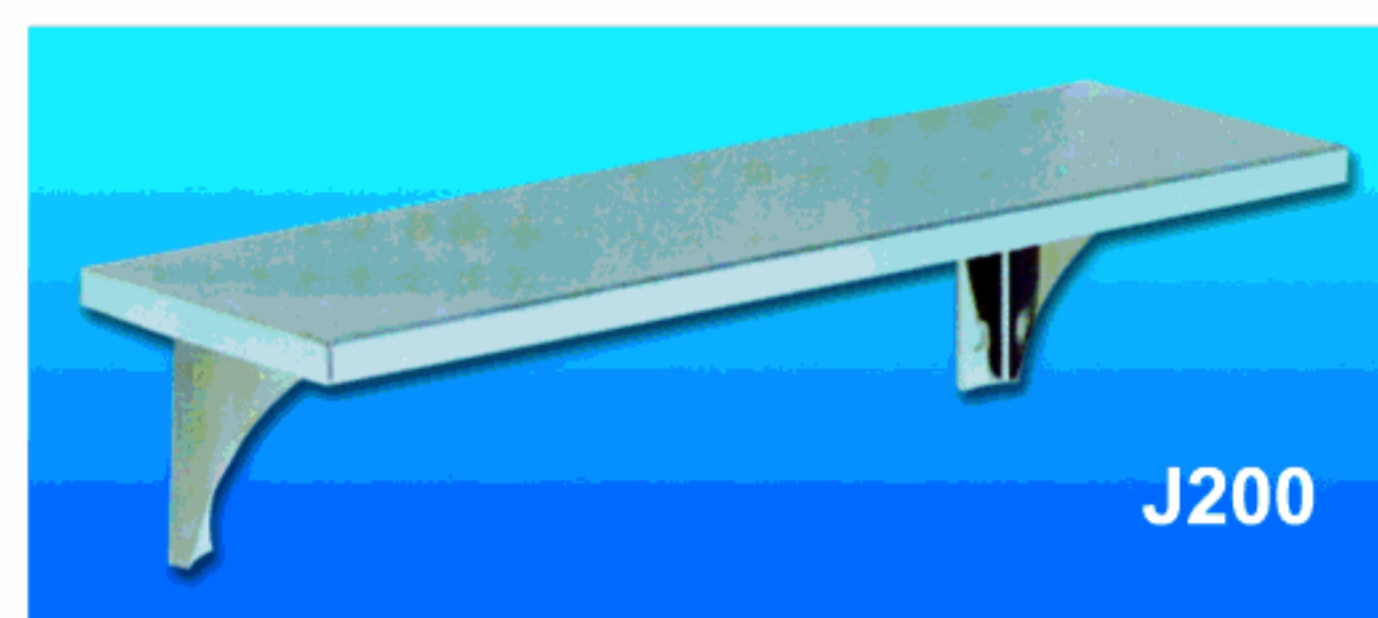

J100 Utility Shelf with Mop Holders & Rag Hooks
 Material: Stainless Steel type 304 gauge 18 Size: 6 1/8"H x 9 1/2" Projection
 Length: 30" (3 Mop & 2 Rag Holder), 36" (4 Mop & 3 Rag Holder),
 46" (5 Mop & 4 Rag Holder), 56" (6 Mop & 5 Rag Holder)

J110 Mop Holders & Rag Hooks
 Material: Stainless Steel type 304 gauge 18 Size: 4 3/4"H x 3 3/4" Projection
 Length: 26" (3 Mop & 2 Rag Hooks), 36" (4 Mop & 3 Rag Hooks),
 46" (5 Mop & 4 Rag Hooks), 56" (6 Mop & 5 Rag Hooks)

J120 Mop & Broom Rack
 Material: Stainless Steel type 304 gauge 20
 Size: 4 3/4"H x 3 3/4" Projection
 Length: 26" w/ 3 holders, 36" w/ 4 holders, 46" w/ 5 holders, or 56" w/ 6 holders

J130 Hat & Coat Hook Strip
 Material: Stainless Steel type 304 gauge 20
 Size: 9"H x 2 1/2" Projection
 Length: 26" w/ 3 hooks, 36" w/ 4 hooks, 46" w/ 5 hooks

J200 Utility Shelf
 Material: Stainless Steel type 304 gauge 20
 Size: 4 1/2"H x 5"D Length: 18", 24", 30" or 36" Long

J900 Surface Mounted Bottle Opener
 Material: Stainless Steel type 304

B901 Shower Curtain Rod
 Material: Stainless Steel type 304 Diameter: 1"
 Size: Made to order straight or Corner Mount

J910 Surface Mounted Retractable Clothesline
 Material: Stainless Steel type 304 Cord Size: 71"

B910 Stainless Steel Curtain Ring

B950 Retractable Shower Seat
 Material: Stainless Steel type 304 Diameter: 1"
 Cover: Waterproof High Pressure Plastic Laminate

B960 Surface Mounted Baby Changing Station (Vertical)

Same as B970, but vertical
 Size: 22"W x 36"H x 5"D 35" when opened

B970 Surface Mounted Baby Changing Station (Horizontal)

Size: 35"W x 20"H x 4"D 19 1/2" when opened

B980 Surface Mounted Child Protection Seat

Size: 12"W x 19"H x 5 3/4"D 12 1/2" when opened

B990 Shower Curtain

موجز عن الشركة

Profile

Building Material Division is one of the divisions of Mohammed Saad Aldrees & Sons Co., Ltd. Group of Companies catering to the construction industry in Saudi Arabia since 1978.

Since its inception the company has offered the construction industry the best in Toilet Partitions representing such legendary companies as Global, Mills, & Bushboard. Now we are proud to introduce a new legend in Toilet Partitions with Flex Partitions manufactured from our new factory in Riyadh. The development of Flex Partitions is based on our years of experience in custom toilet partitions, supplying countless prestigious projects throughout Saudi Arabia.

قطاع مواد البناء إحدى مجموعة شركات محمد سعد الدريس وأولاده المحدودة في مجال تأمين احتياجات قطاع الإنشاءات في المملكة العربية السعودية منذ عام ١٩٧٨.

منذ تم إنشاء الشركة وهي تؤمن لقطاع الإنشاءات أفضل قواطع دورات المياه من إنتاج شركات عالمية مثل قلوبل ، مليز ، بش بوردد. والآن نحن فخورين بأن نقدم لكم إنجازاً جديداً من قواطع دورات المياه بتقديم فليكس لقواطع دورات المياه المصنعة في مصنعنا الواقع في مدينة الرياض. تم تطوير قواطع دورات المياه فليكس على أساس خبرتنا الطويلة في مجال توريد قواطع دورات المياه وكافة الملحقات من إكسسوارات الستنلس ستيل الخاصة بالدورات لعدد لا يحصى من المشاريع الكبرى في كافة أنحاء المملكة العربية السعودية .

* Why Flex is the Best ...?

1. Our products meet the European and American Standards.
2. We are backed by many years of experience in the market and pay close attention to our customer's needs and take pride in our customer's trust.
3. We provide complete package toilet partitions and toilet accessories.
4. Our quality standards and attention to detail are unequalled in the industry.
5. Our fabricating equipments are state-of-the-art. You are not only assured of a wide variety of special capabilities, but also meticulous, quality workmanship of the finished products.
6. You can count on us for prompt, courteous service and quality workmanship.
7. Our management and staff are not only experienced and knowledgeable, but also sincerely committed to customer service.

* لماذا قواطع فليكس هي الأفضل....؟

- ١- تطابق منتجاتنا للمعايير والمواصفات العالمية الأمريكية والأوروبية منها .
- ٢- تدعمنا خبرة سنوات عديدة في السوق ونعير احتياجات عملائنا إهتماماً لالمحدود ، كما إننا نفتخر بثقة عملائنا بنا .
- ٣- نقدم مجموعة متكاملة من قواطع دورات مياه وأكسسواراتها من الستنلس ستيل .
- ٤- إن مواصفاتنا القياسية للجودة واهتمامنا بالتفاصيل لاتضاهيها في صناعة الدورات.
- ٥- إن معدات صناعة الدورات لدينا هي الأحدث ، فإن تضمن فقط الحصول على إمكانيات خاصة متنوعة ولكن أيضاً ستحصل على مصنعية تهتم بالتفاصيل الدقيقة .
- ٦- يمكنك الاعتماد علينا لخدمة فورية ومصنعية ذات جودة .
- ٧- إن إدارتنا والعمالين ليسوا فقط ذوي خبره ودراية لكنهم أيضاً ملتزمون بإخلاص وتفاني في خدمة المستهلك .

FLEX BY ALDREES CO.
TAKES YOU TO A NEW HEIGHT OF SATISFACTION

إن فليكس من قبل شركة الدريس
تصل بك إلى قمة الرضا .

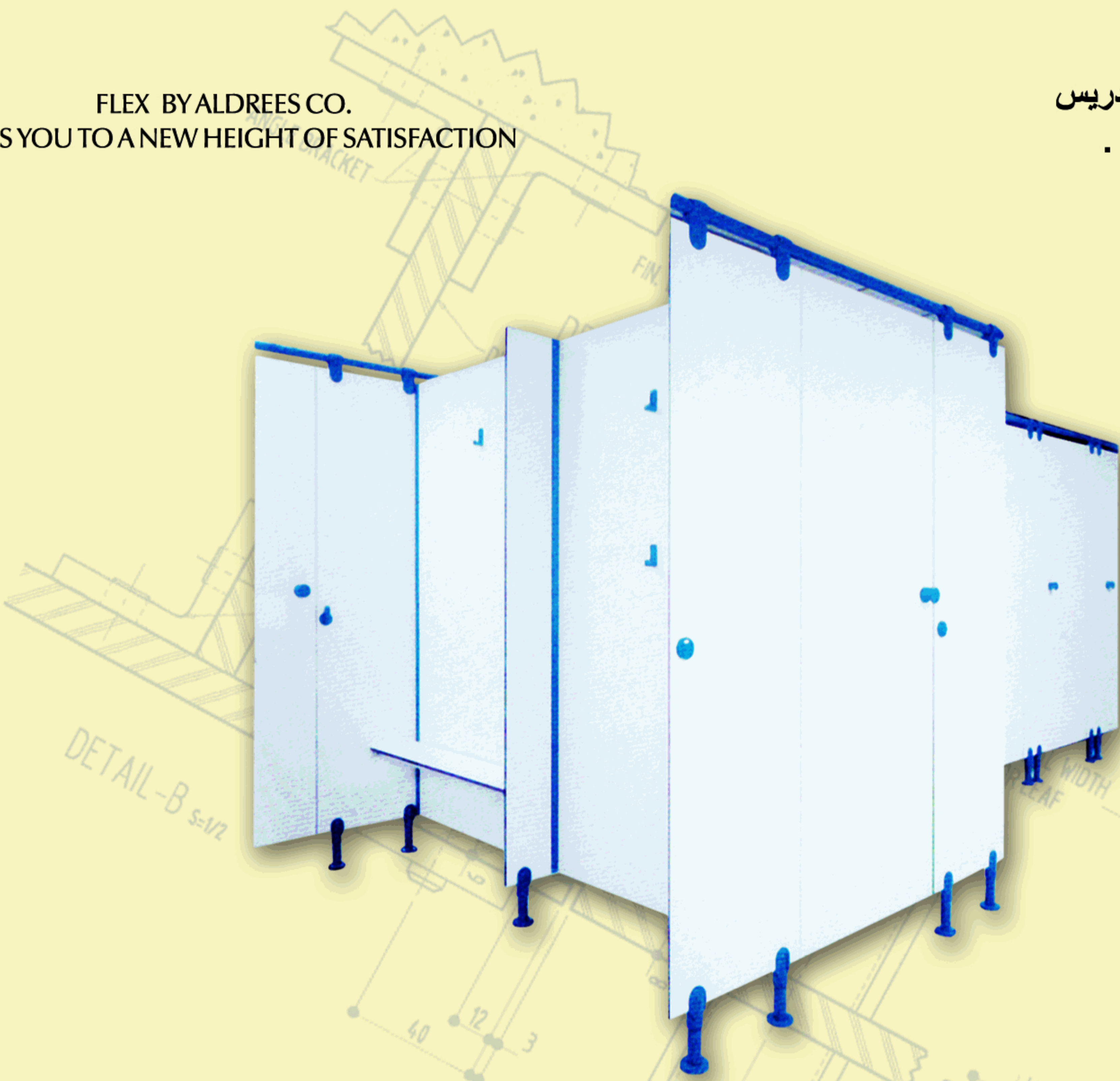

Material Properties

Material Properties

| Properties | Value | Unit | Standard |
|---|-------------------|-------------------|----------|
| Physical Properties | | | |
| Weight Thickness 13 mm | 18.4 | Kg/m ² | |
| Thickness 19mm | 27.0 | Kg/m ² | |
| Panel Tolerance | | | |
| Length and Width | 00/+5 | mm | |
| Thickness | ±0.5 for 13 | mm | |
| | ±0.6 for 19 | mm | |
| Optical Properties | | | |
| Changes when subjected to dry heat (maximum temperature of 180°C) | | | EN 438 |
| gloss | colour | cracking | |
| no changes | no changes | no changes | |
| Mechanical Properties | | | |
| Userface impact resistance | | | |
| Plain colours | 4 | Index number | EN 438 |
| Scratch resistance | | | |
| Plain colour, light | 4 | Index number | EN 438 |
| Plain colour, dark | 3 | Index number | EN 438 |
| Wear resistance | | | |
| Plain colours | 3 | Index number | EN 438 |
| Water absorption | ≤1.0 | % weight | EN 438 |
| Thermal properties | | | |
| Application temperature | -10 to 80 | | |
| | -40 to 130 | °C | |
| Panel tolerance | | | |
| Length & Width | 0.0/±5 | mm | |
| Thickness | ±0.6 for 13 | mm | |
| | ±0.6 for 19 | mm | |
| Fire Test | | | |
| Germany | Type FR: Class B1 | DIN 4102 | |

فلكس قواطع الحمامات

من الفينوليك المتين وهو بلاستيك من النوع المتين والفريد الذي يقاوم التقشر حتى في أقسى أحوال البخار أو الماء أو التنظيف . كما أنها تمتاز بخاصية امتصاص الأصوات والمثانة مما يجعلها خياراً ممتازاً لكلا من قواطع الحمامات والمراش . توفر أسطح المغاسل المقاومة للماء يجعلها مثالية كنظام متكامل متناسق الألوان .

مجالات الاستخدام

للمناطق الرطبة والمبللة . تقاوم تأثير المياه والزيوت والبكتيريا . وهي تقاوم آثار عمليات التنظيف وينصح باستخدامها في التركيبات الخارجية كغرف المراوش والمساح والمعارض .

الأبواب

- مصنوعة من الفينوليك المتين سماكة ١٣ ملم . كما ستكون الحواف مفروزة لتأمين الخصوصية .
- مقاسات الأبواب ٦١٠ ملم .
- مقاسات الأبواب الخاصة بالمعوقين ٩١٠ ملم .
- ارتفاع الأبواب القياسية ١٨٠٠ ملم .

ألواح القواطع

- مصنوعة من الفينوليك المتين سماكة ١٣ ملم . الحواف مشطوفة ومدورة قليلاً .
- عرض الألواح القياسية ١٥٠٠ ملم .
- ارتفاع الألواح القياسية ١٨٥٠ ملم .

القوائم

- مصنوعة من الفينوليك المتين سماكة ١٣ ملم . الحواف مفروزة لتحقيق الخصوصية .
- عرض القائم ٧٥ - ١٠٠ - ١٢٥ - ١٥٠ - ٢٠٠ - ٢٥٠ - ٣٠٠ - ٣٥٠ - ٤٠٠ ملم .
- ارتفاع القائم ١٨٥٠ ملم .

الأكسسوارات

- مصنوعة من مواد غير قابله للصدأ .
- متوفرة باللون الأسود .

Flex Toilet Partitions

- Solid Phenolic Core is a unique solid plastic material which is resistant to delamination even under severe steam, water, or hose down conditions. Sound-absorption and rigidity make it an excellent choice for both toilet and shower partitions. Matching waterproof counter tops are available to create a complete color-coordinated installation.

Applications

- Humid and wet areas. Resists water, oil, and bacteria. Withstands hose down cleaning recommended for outdoor parks, pools, and shower rooms.

Doors

- Shall be 13 mm. thick solid phenolic core. Edges shall be rebated for privacy.
- Standards door size 610 mm.
- Handicapped door size is 910 mm.
- Standard door height is 1800 mm.

Panels

- Shall be 13 mm. thick solid phenolic core. Edges shall be burnished and slightly rounded.
- Standard Panel width is 1500 mm.
- Standard Panel height is 1850 mm.

Pilasters

- Shall be 13 mm. thick solid phenolic core. Edges shall be rebated for privacy.
- Pilaster width 75 - 100 - 125 - 150 - 200 - 250 - 300 - 350 - 400mm
- Pilaster height 1850mm

Hardware

- All hardware are made of non-ferrous materials.
- Available in Black Color.

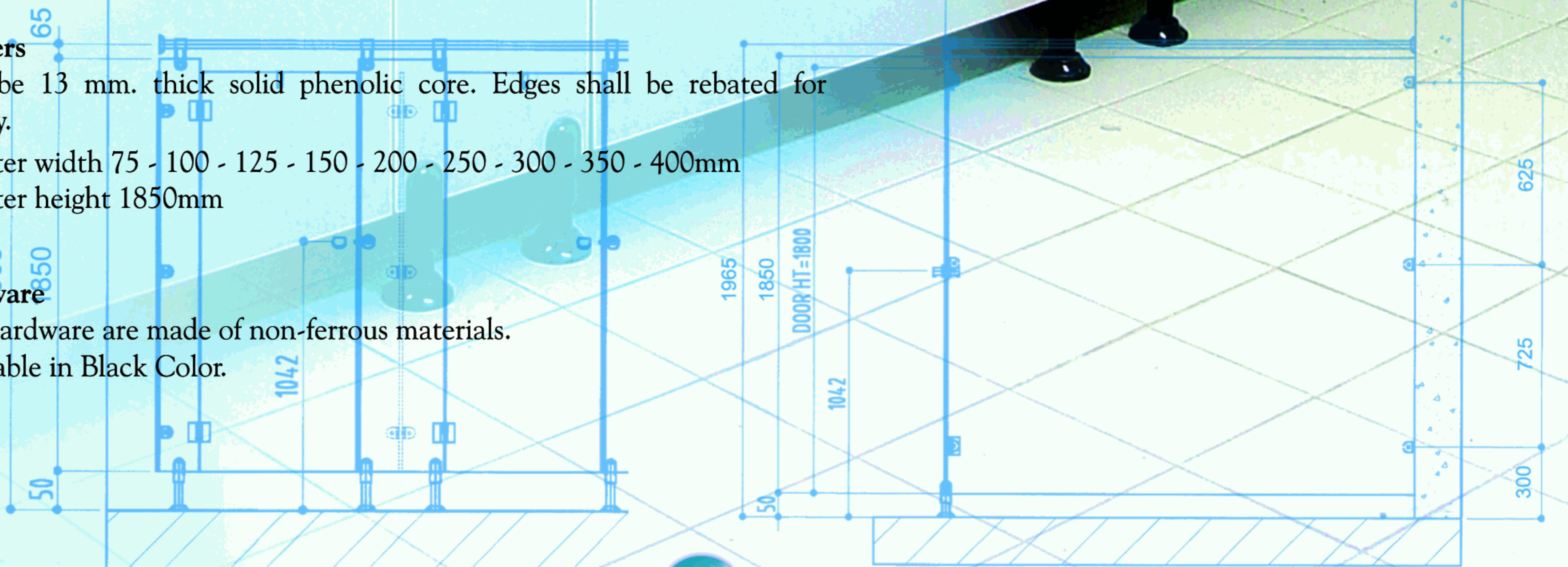

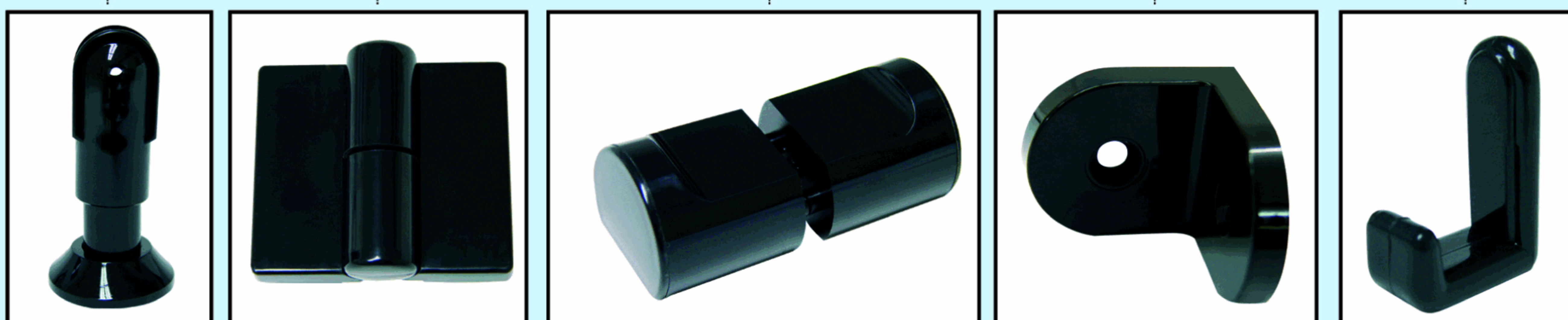
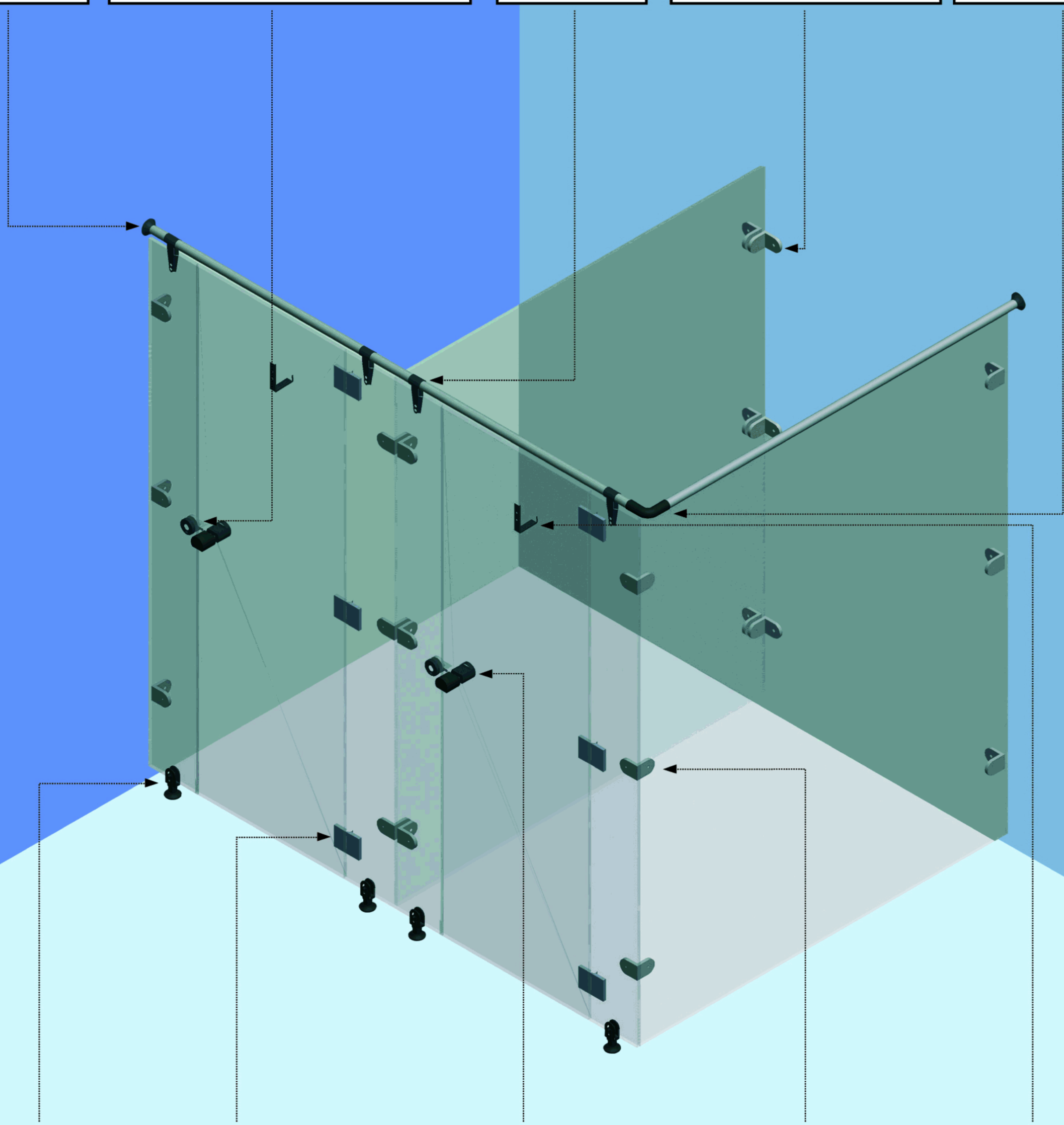

فلكس قواطع الحمامات

من الفينوليك المتين وهو بلاستيك من النوع المتين والفريد الذي يقاوم التقشر حتى في أقسى أحوال البخار أو الماء أو التنظيف . كما أنها تتميز بخاصية امتصاص الأصوات والمتانة مما يجعلها خياراً ممتازاً لكلاً من قواطع الحمامات والمرآش . توفر أسطح المغاسل المقاومة للماء يجعلها مثالية كنظام متكامل متناسق الألوان .

مجالات الإستخدام

للمناطق الرطبة والمبللة . تقاوم تأثير المياه والزيوت والبكتيريا . وهي تقاوم آثار عمليات التنظيف وينصح باستخدامها في التركيبات الخارجية كغرف المرآش والمساح والمعارض .

الأبواب

- مصنوعة من الفينوليك المتين سماكة ١٩ ملم . كما ستكون الحواف مفروزة لتأمين الخصوصية
- مقاسات الأبواب ٦١٠ ملم .
- مقاسات الأبواب الخاصة بالمعوقين ٩١٠ ملم .
- ارتفاع الأبواب القياسية ١٨٥٠ ملم .

ألواح القواطع

- مصنوعة من الفينوليك المتين سماكة ١٣ ملم . الحواف مشطوفة ومدورة قليلاً .
- عرض الألواح القياسية ١٥٠٠ ملم .
- ارتفاع الألواح القياسية ١٨٥٠ ملم .

القوائم

- مصنوعة من الفينوليك المتين سماكة ١٩ ملم . الحواف مفروزة لتحقيق الخصوصية.
- عرض القائم ٧٥ - ١٠٠ - ١٢٥ - ١٥٠ - ٢٠٠ - ٢٥٠ - ٣٠٠ - ٣٥٠ - ٤٠٠ ملم .
- ارتفاع القائم ٢٠٠٠ ملم

الأكسسوارات

- مصنوعة من مواد غير قابله للصدأ .

Flex Toilet Partitions

- Solid Phenolic Core is a unique solid plastic material which is resistant to delamination even under severe steam, water, or hose down conditions. Sound-absorption and rigidity make it an excellent choice for both toilet and shower partitions. Matching waterproof counter tops are available to create a complete color-coordinated installation.

Applications

- Humid and wet areas. Resists water, oil, and bacteria. Withstands hose down cleaning recommended for outdoor parks, pools, and shower rooms.

Doors

- Shall be 19 mm. thick solid phenolic core. Edges shall be rebated for privacy.
- Standards door size 610 mm.
- Handicapped door size is 910 mm.
- Standard door height is 1850 mm.

Panels

- Shall be 13 mm. thick solid phenolic core. Edges shall be burnished and slightly rounded.
- Standard Panel width is 1500 mm.
- Standard Panel height is 1850 mm.

Pilasters

Shall be 19 mm. thick solid phenolic core. Edges shall be rebated for privacy.

- Pilaster width 75 - 100 - 125 - 150 - 200 - 250 - 300 - 350 - 400mm
- Pilaster height 2000mm

Hardware

- All hardware are made of non-ferrous materials.

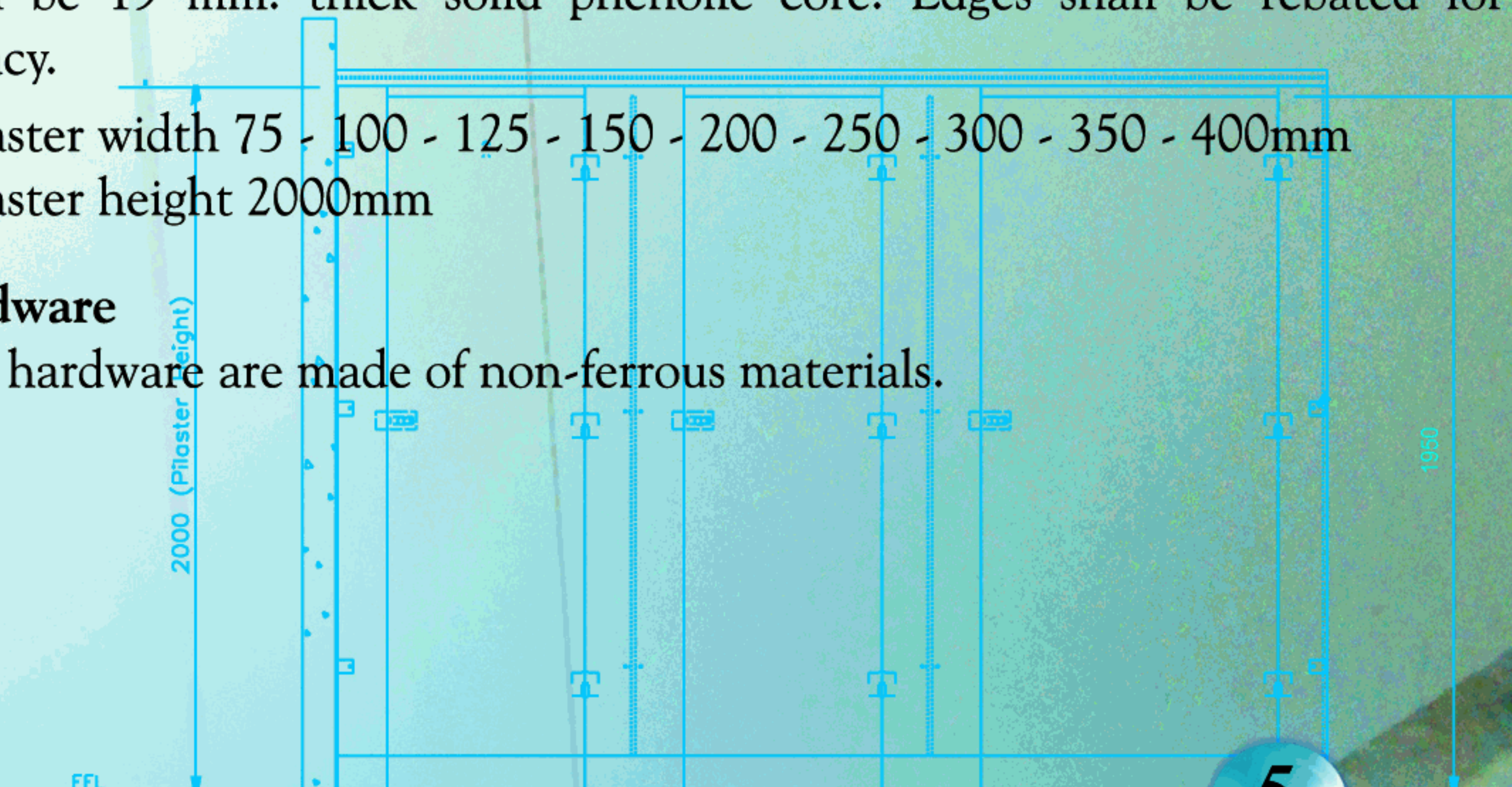

MODEL T2000

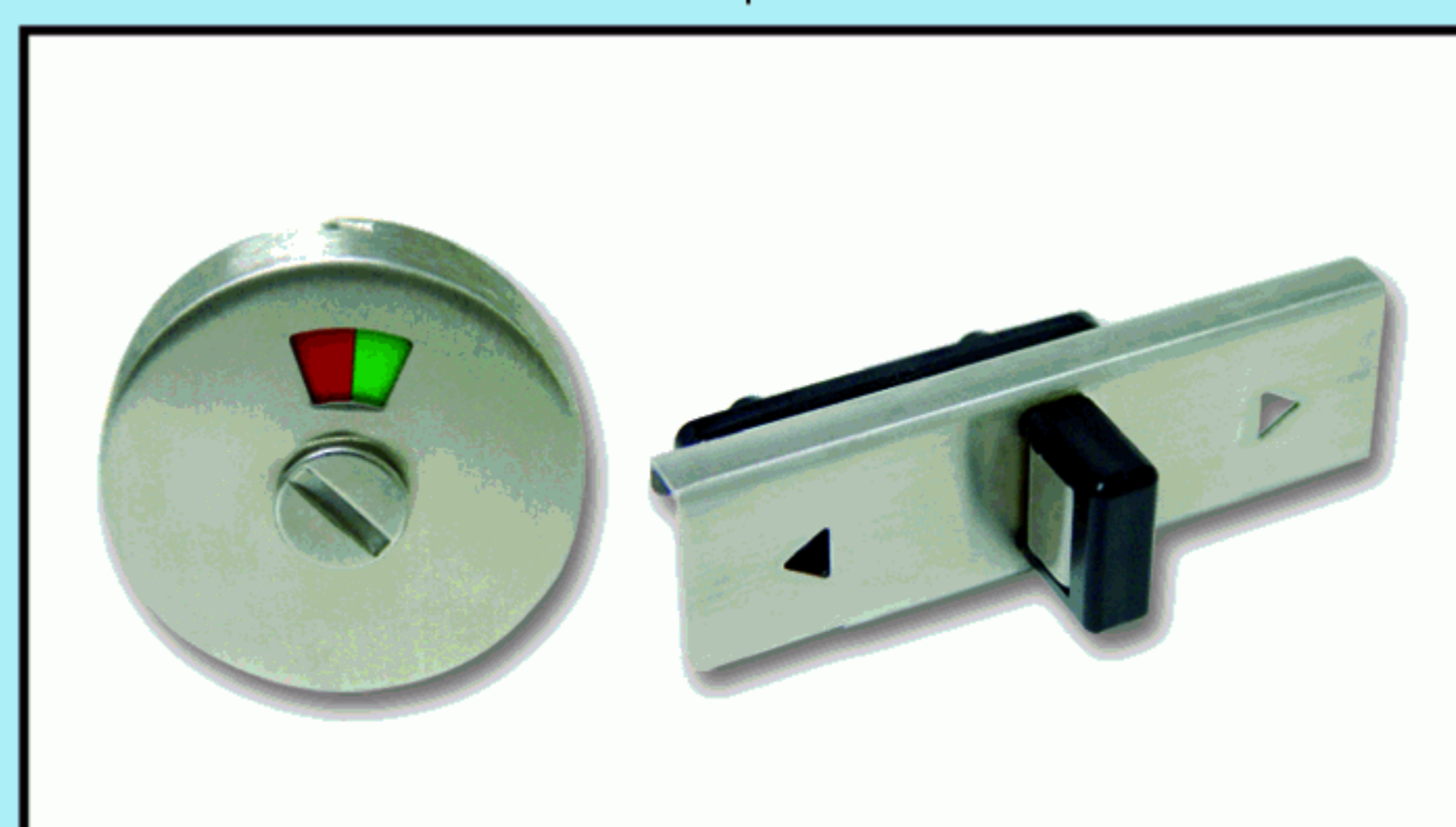
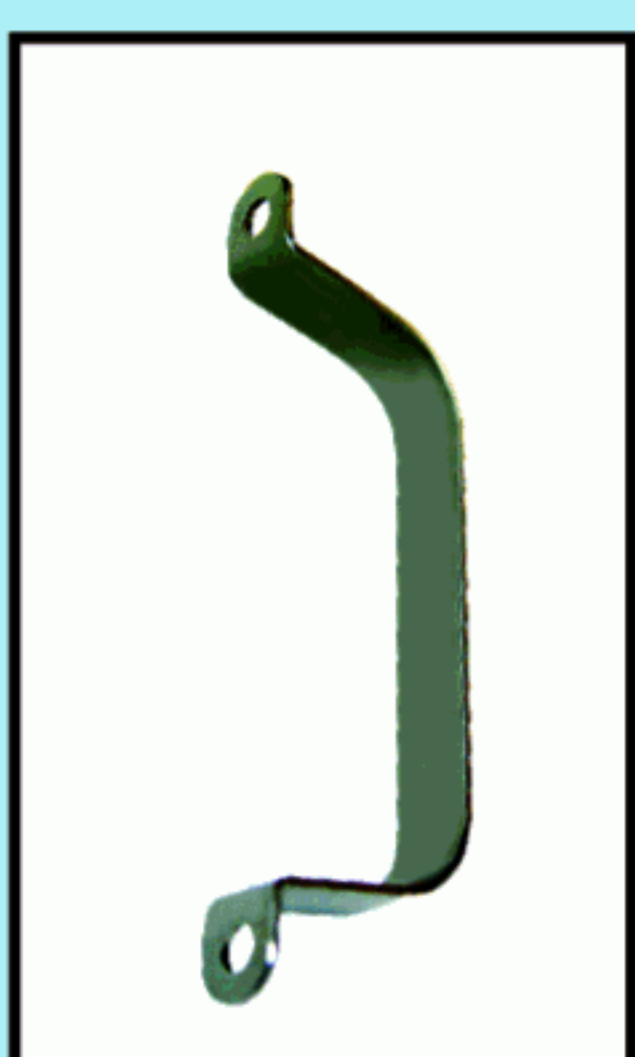
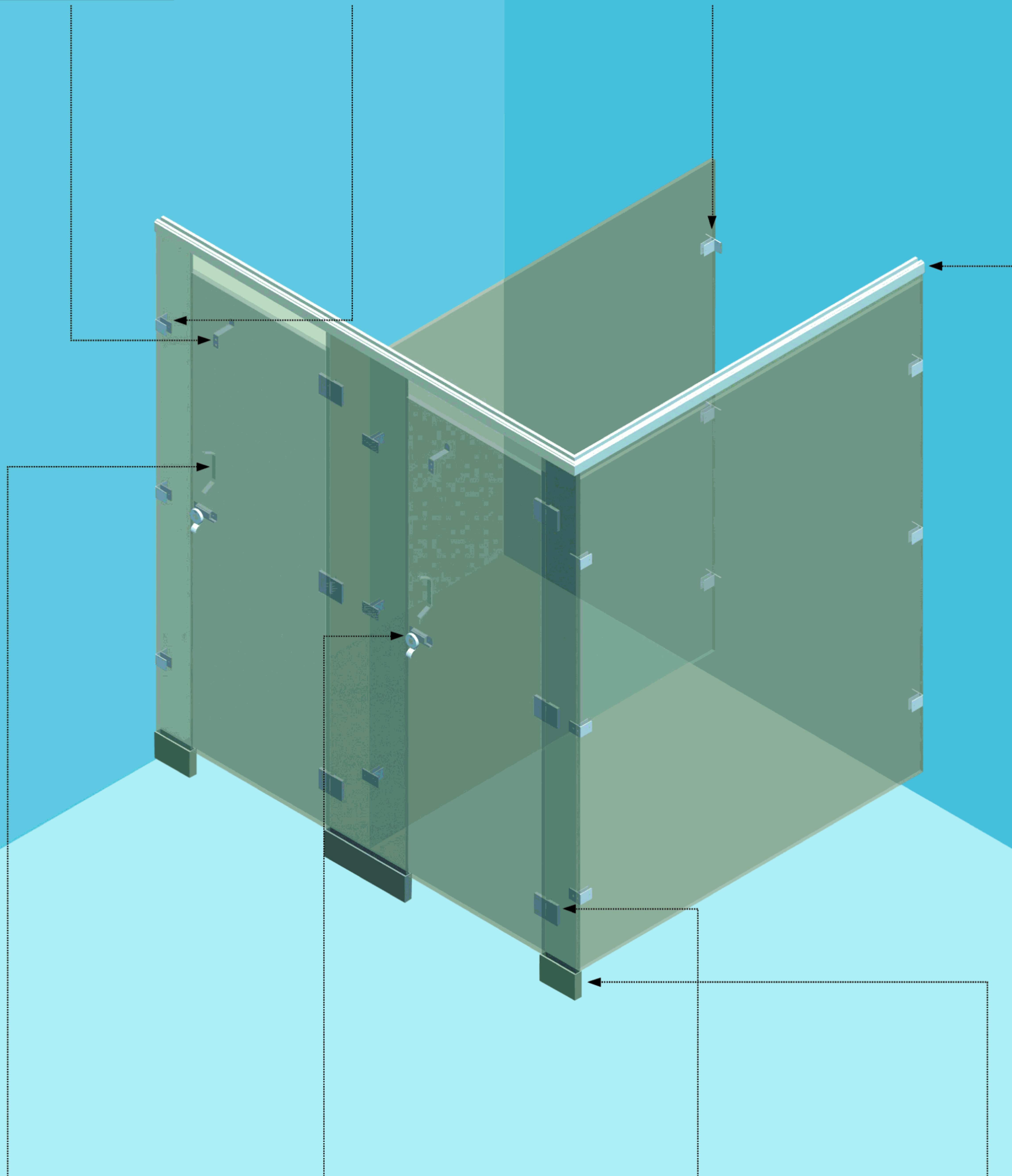
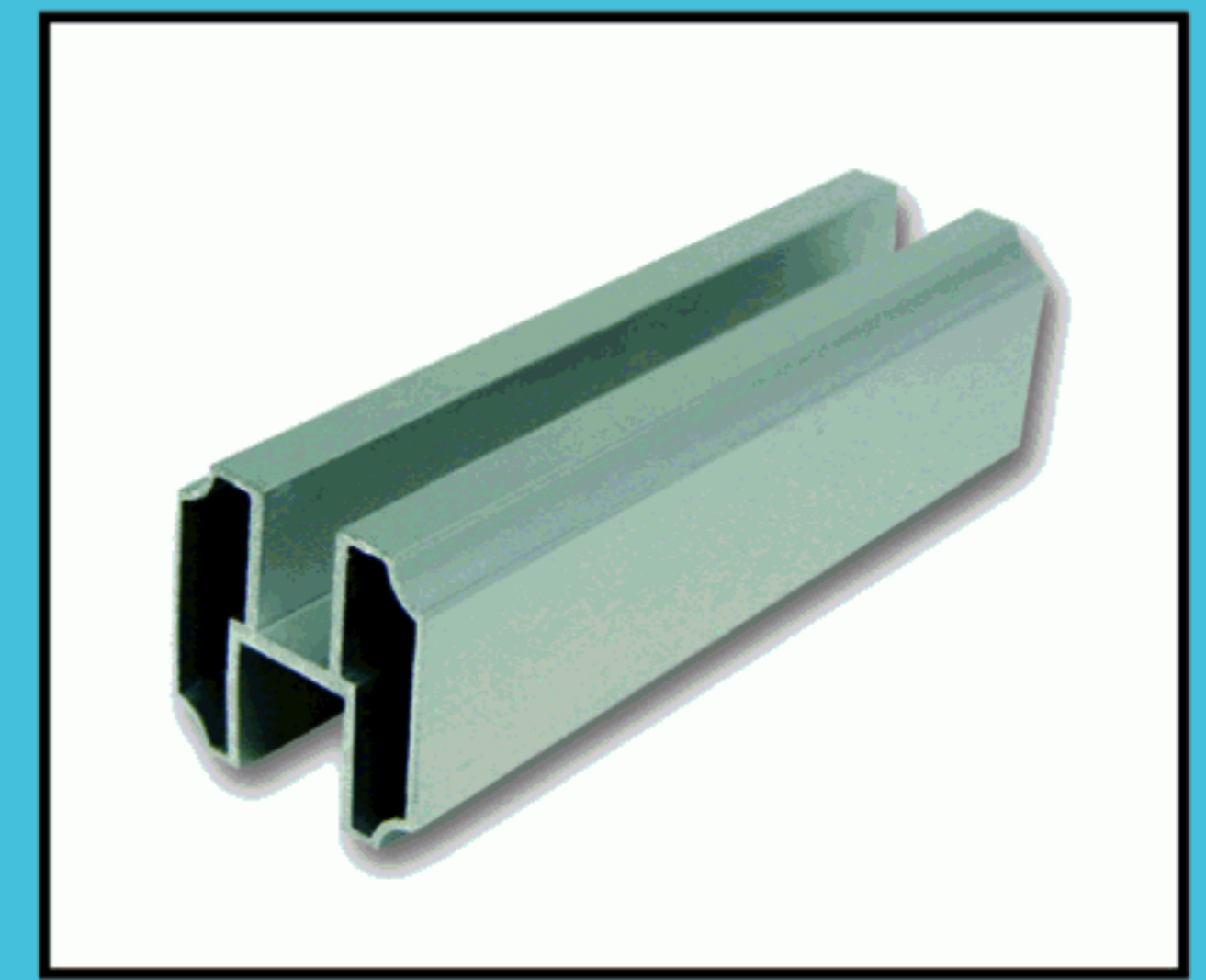
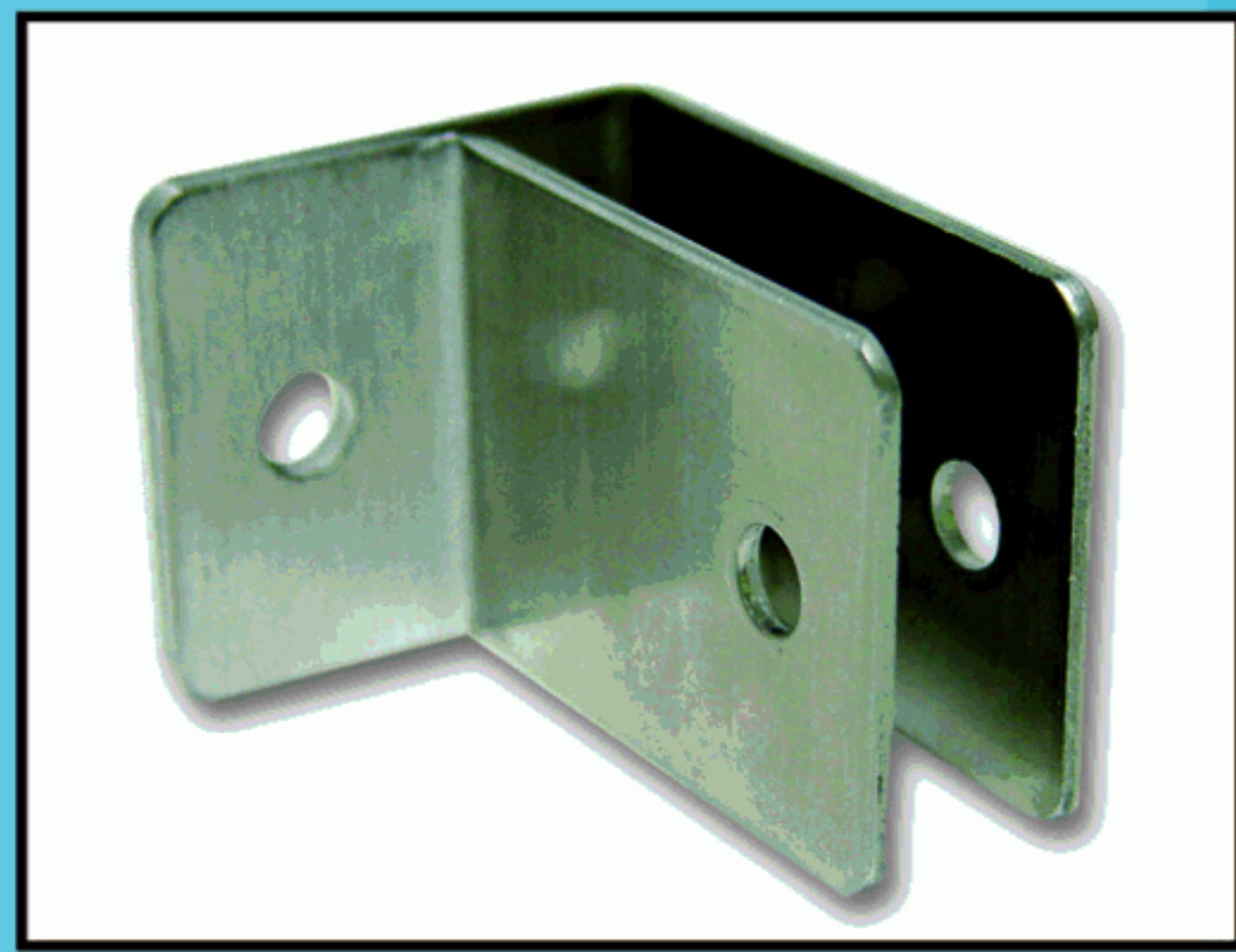

غرف مروش فينوليك الجاهزة

الأبواب والقواطع والقوائم مصنوعة من الفينوليك سماكة ١٣ ملم كما هو موضح في مواصفات قواطع الحمامات . وتضم حاجز رأسي من عوارض الالمنيوم قطعة واحدة بقطر ٣٢ ملم تثبت على الجدار لتأمين الثبات والقوة مع القوائم وهي ذات قواعد من النوع القابل للتعديل والمثبتة بقوه على الارضية . جميع أدوات التثبيت لكامل غرفة المروش مصنوعة من مواد غير قابله للصداً .

Door, Divided Panels and Pilasters are made up of 13mm thick solid Phenolic Core as mentioned in the specification of toilet cubicle. A continuous extruded aluminum tube (32mm dia) head rail fixed to the wall provides strength and stability along with Pilasters adjustable leg support strongly fixed to the floor. Non-ferrous hardware have to be furnished for complete cubicle fixing.

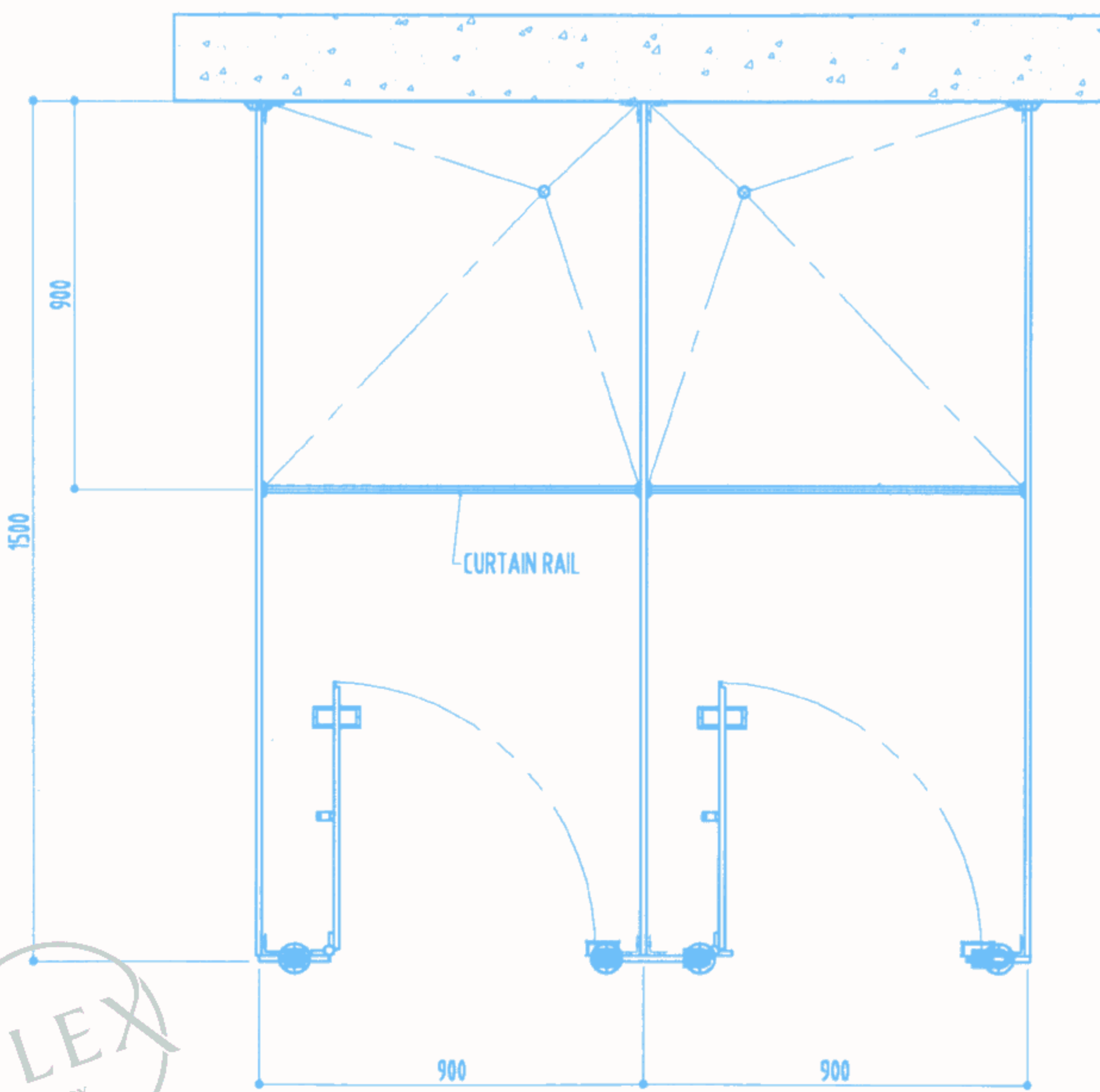



We Care...



| | | |
|--|--|-----------------------|
| FORWARD REACH Max: 48"(1220mm) Min: 15"(380mm) | SIDE REACH Max: 54"(1307mm) Min: 9"(230mm) | COMBINED REACH |
|--|--|-----------------------|

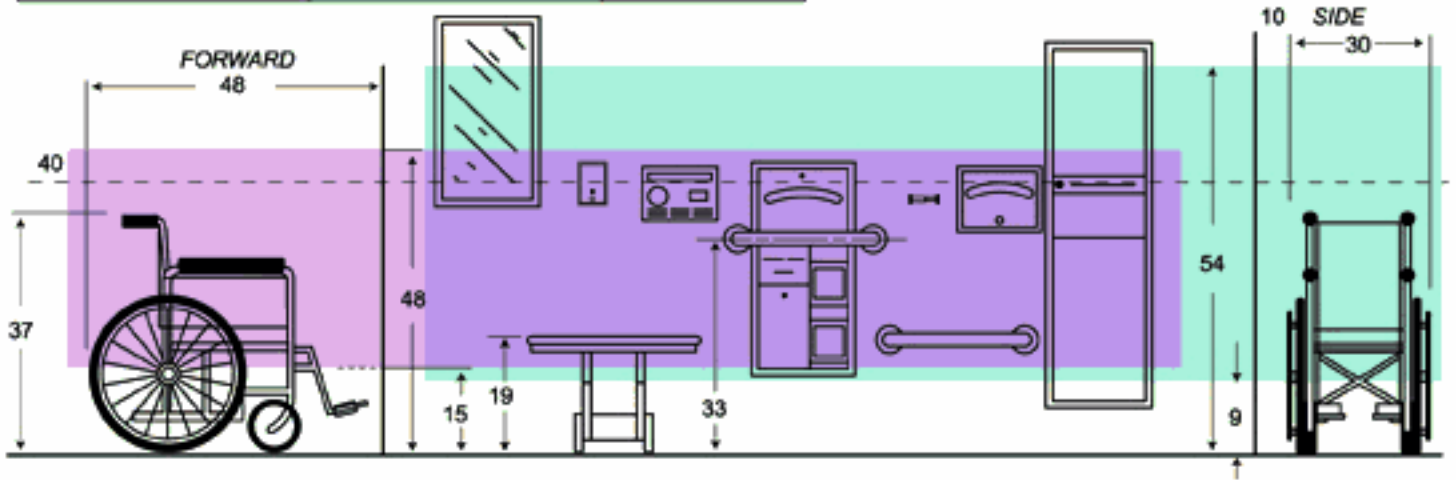

C O L O R S



RED - T10



BLUE - T20



BLACK - T30



ALMOND - T40



WARM GRAY - T50



MUSTARD - T60



GREEN - T70



WHITE - T80



GRAY - T90



MOHAMMED SAAD ALDREES & SONS CO.
P.O. Box 15273 Riyadh 11444 • Tel.: 477-8700 Fax.: 476-3947
www.flexpartitions.com

* We reserves the right to alter design or dimensions without formal notice and without incurring obligation.

Material Properties

Material Properties

| Properties | Value | Unit | Standard |
|---|---------------------|-------------------|---------------------|
| Physical Properties | | | |
| Weight | Thickness 13 mm | 18.4 | Kg/m ² |
| | Thickness 19mm | 27.0 | Kg/m ² |
| Panel Tolerance | | | |
| | Length and Width | 00/+5 | mm |
| | Thickness | ±0.5 for 13 | mm |
| | | ±0.6 for 19 | mm |
| Optical Properties | | | |
| Changes when subjected to dry heat (maximum temperature of 180°C) | | | EN 438 |
| | gloss | colour | cracking |
| | no changes | no changes | no changes |
| Mechanical Properties | | | |
| Userface impact resistance | | | |
| | Plain colours | 4 | Index number EN 438 |
| Scratch resistance | | | |
| | Plain colour, light | 4 | Index number EN 438 |
| | Plain colour, dark | 3 | Index number EN 438 |
| Wear resistance | | | |
| | Plain colours | 3 | Index number EN 438 |
| | Water absorption | ≤1.0 | % weight EN 438 |
| Thermal properties | | | |
| Application temperature | | -10 to 80 | |
| | | -40 to 130 | °C |
| Panel tolerance | | | |
| | Length & Width | 0.0/±5 | mm |
| | Thickness | ±0.6 for 13 | mm |
| | | ±0.6 for 19 | mm |
| Fire Test | | | |
| | Germany | Type FR: Class B1 | DIN 4102 |

فكس قواطع الحمامات

من الفينوليك المتين وهو بلاستيك من النوع المتين والفريد الذي يقاوم التقشر حتى في أقسى أحوال البخار أو الماء أو التنظيف . كما أنها تمتاز بخاصية امتصاص الأصوات والمثانة مما يجعلها خياراً ممتازاً لكلاً من قواطع الحمامات والمرآش . توفر أسطح المغاسل المقاومة للماء يجعلها مثالية كنظام متكامل متناسق الألوان .

مجالات الاستخدام

للمناطق الرطبة والمبيلة . تقاوم تأثير المياه والزيوت والبكتيريا . وهي تقاوم آثار عمليات التنظيف وينصح باستخدامها في التركيبات الخارجية كغرف المراوش والمساح والمعارض .

الأبواب

- مصنوعة من الفينوليك المتين سماكة ١٣ ملم . كما ستكون الحواف مفروزة لتأمين الخصوصية .
- مقاسات الأبواب ٦١٠ ملم .
- مقاسات الأبواب الخاصة بالمعوقين ٩١٠ ملم .
- ارتفاع الأبواب القياسية ١٨٠٠ ملم .

أنواع القواطع

- مصنوعة من الفينوليك المتين سماكة ١٣ ملم . الحواف مشطوفة ومدورة قليلاً .
- عرض الألواح القياسية ١٥٠٠ ملم .
- ارتفاع الألواح القياسية ١٨٥٠ ملم .

القوائم

- مصنوعة من الفينوليك المتين سماكة ١٣ ملم . الحواف مفروزة لتحقيق الخصوصية .
- عرض القائم ٧٥ - ١٠٠ - ١٢٥ - ١٥٠ - ٢٠٠ - ٢٥٠ - ٣٠٠ - ٣٥٠ - ٤٠٠ ملم
- ارتفاع القائم ١٨٥٠ ملم .

الأكسسوارات

- مصنوعة من مواد غير قابلة للصدأ .
- متوفرة باللون الأسود .

Flex Toilet Partitions

- Solid Phenolic Core is a unique solid plastic material which is resistant to delamination even under severe steam, water, or hose down conditions. Sound-absorption and rigidity make it an excellent choice for both toilet and shower partitions. Matching waterproof counter tops are available to create a complete color-coordinated installation.

Applications

- Humid and wet areas. Resists water, oil, and bacteria. Withstands hose down cleaning recommended for outdoor parks, pools, and shower rooms.

Doors

- Shall be 13 mm. thick solid phenolic core. Edges shall be rebated for privacy.
- Standards door size 610 mm.
- Handicapped door size is 910 mm.
- Standard door height is 1800 mm.

Panels

- Shall be 13 mm. thick solid phenolic core. Edges shall be burnished and slightly rounded.
- Standard Panel width is 1500 mm.
- Standard Panel height is 1850 mm.

Pilasters

- Shall be 13 mm. thick solid phenolic core. Edges shall be rebated for privacy.
- Pilaster width 75 - 100 - 125 - 150 - 200 - 250 - 300 - 350 - 400mm
- Pilaster height 1850mm

Hardware

- All hardware are made of non-ferrous materials.
- Available in Black Color.

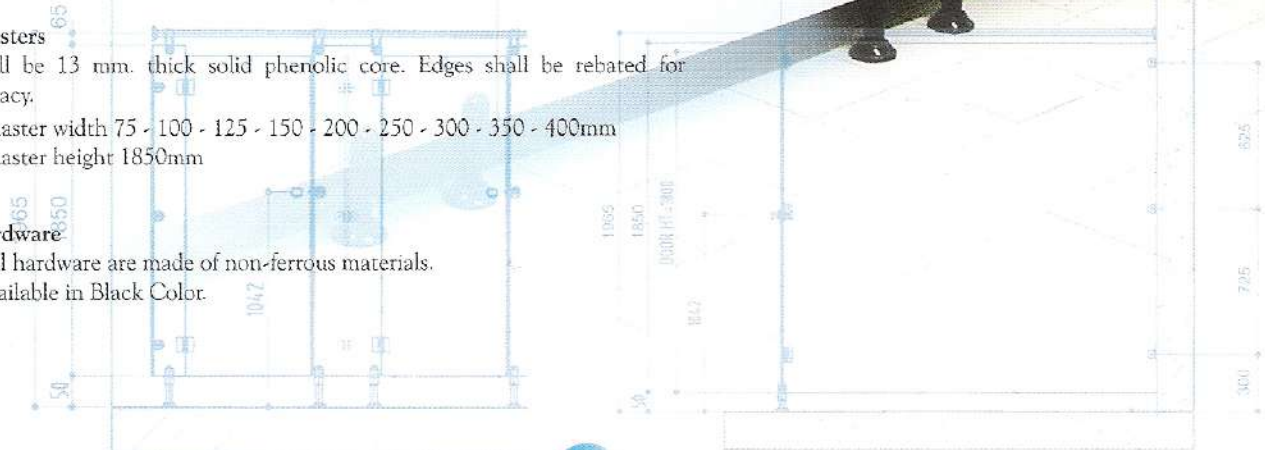

MODEL T1000

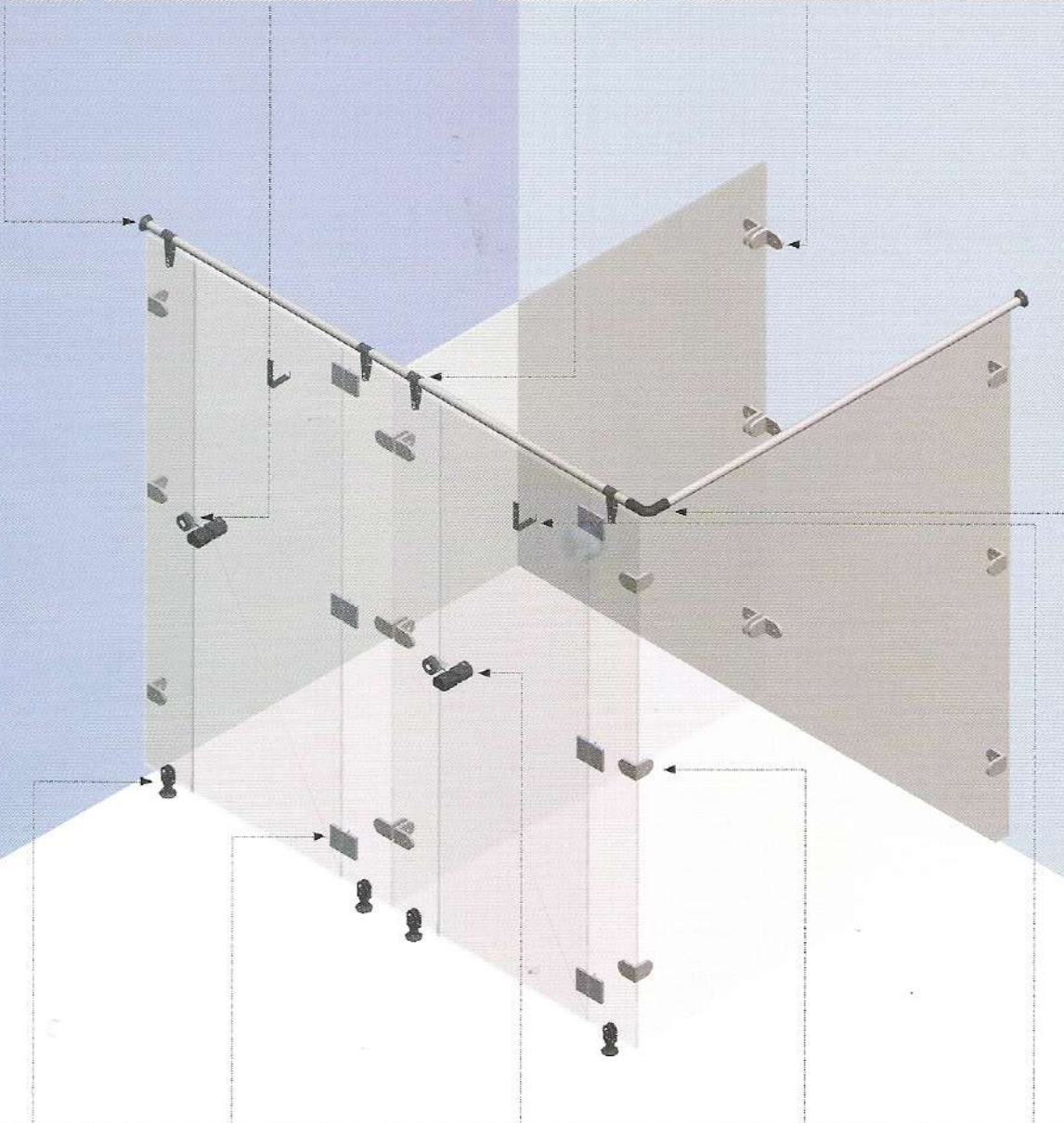
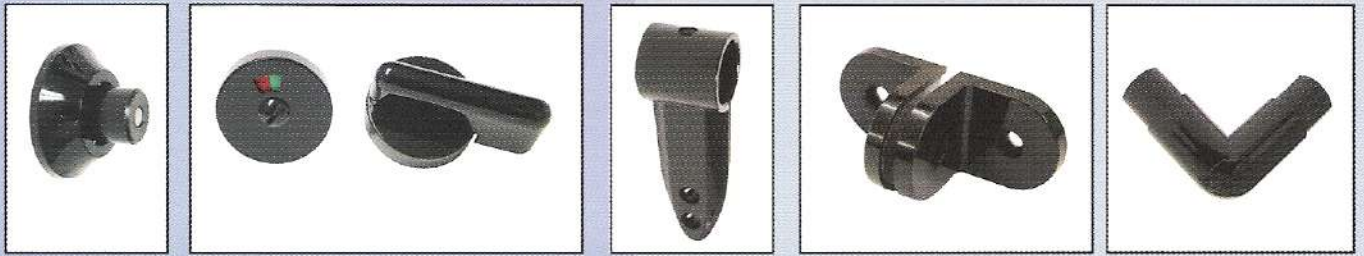

فلنكس قواطع الحمامات

من الفينوليك المتين وهو بلاستيك من النوع المتين والفريد الذي يقاوم التفتش حتى في أقسى أحوال البخار أو الماء أو التنظيف . كما أنها تمتاز بخاصية امتصاص الأصوات والمتانة مما يجعلها خياراً ممتازاً لكلاً من قواطع الحمامات والمرآش . توفر أسطح المغاسل المقاومة للماء يجعلها مثالية كنظام متكامل متناسق الألوان .

مجالات الاستخدام

للمناطق الرطبة والمبللة . تقاوم تأثير المياه والزيوت والبكتيريا . وهي تقاوم آثار عمليات التنظيف وينصح باستخدامها في التركيبات الخارجية كغرف المراوش والمساح والمعارض .

الأبواب

- مصنوعة من الفينوليك المتين سماكة ١٩ ملم . كما ستكون الحواف مفروزة لتأمين الخصوصية
- مقاسات الأبواب ٦١٠ ملم .
- مقاسات الأبواب الخاصة بالمعوقين ٩١٠ ملم .
- ارتفاع الأبواب القياسية ١٨٥٠ ملم .

ألواح القواطع

- مصنوعة من الفينوليك المتين سماكة ١٣ ملم . الحواف مشطوفة ومدورة قليلاً .
- عرض الألواح القياسية ١٥٠٠ ملم .
- ارتفاع الألواح القياسية ١٨٥٠ ملم .

القوائم

- مصنوعة من الفينوليك المتين سماكة ١٩ ملم . الحواف مفروزة لتحقيق الخصوصية.
- عرض القائم ٧٥ - ١٠٠ - ١٢٥ - ١٥٠ - ٢٠٠ - ٢٥٠ - ٣٠٠ - ٣٥٠ - ٤٠٠ ملم .
- ارتفاع القائم ٢٠٠٠ ملم

الأكسسوارات

- مصنوعة من مواد غير قابله للصدا .

Flex Toilet Partitions

- Solid Phenolic Core is a unique solid plastic material which is resistant to delamination even under severe steam, water, or hose down conditions. Sound-absorption and rigidity make it an excellent choice for both toilet and shower partitions. Matching waterproof counter tops are available to create a complete color-coordinated installation.

Applications

- Humid and wet areas. Resists water, oil, and bacteria. Withstands hose down cleaning recommended for outdoor parks, pools, and shower rooms.

Doors

- Shall be 19 mm. thick solid phenolic core. Edges shall be rebated for privacy.
- Standards door size 610 mm.
- Handicapped door size is 910 mm.
- Standard door height is 1850 mm.

Panels

- Shall be 13 mm. thick solid phenolic core. Edges shall be burnished and slightly rounded.
- Standard Panel width is 1500 mm.
- Standard Panel height is 1850 mm.

Pilasters

Shall be 19 mm. thick solid phenolic core. Edges shall be rebated for privacy.

- Pilaster width 75 - 100 - 125 - 150 - 200 - 250 - 300 - 350 - 400mm
- Pilaster height 2000mm

Hardware

- All hardware are made of non-ferrous materials.

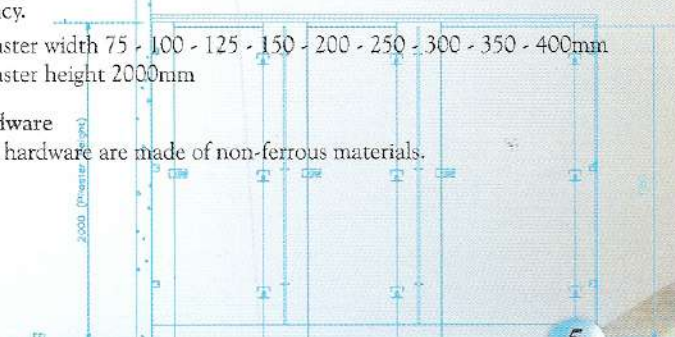

MODEL T2000

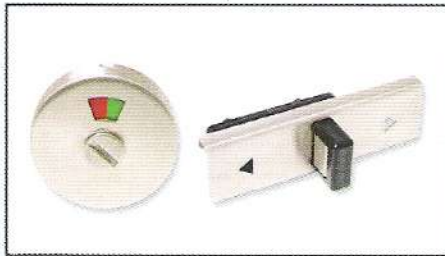
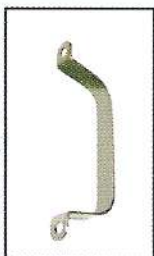
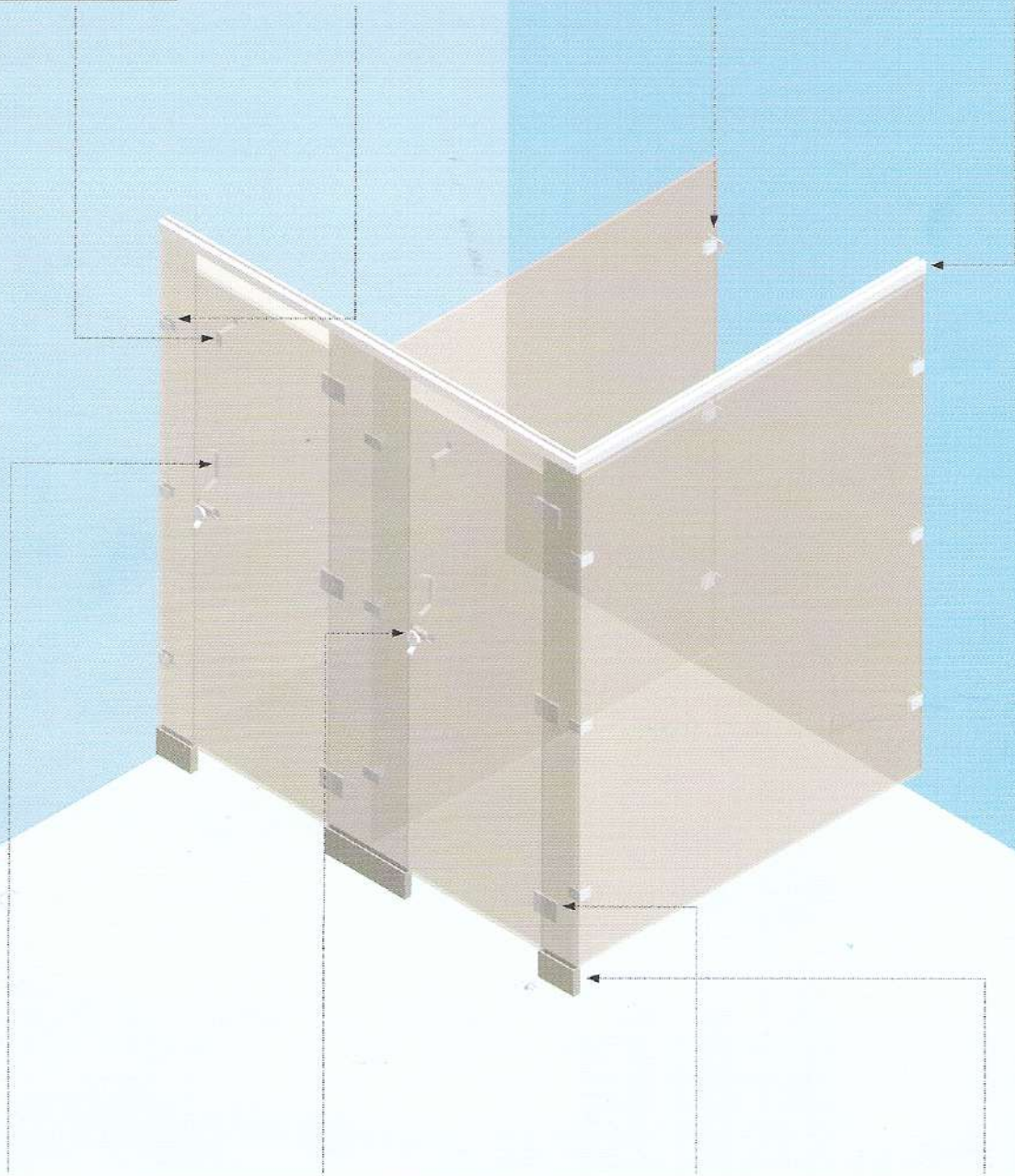
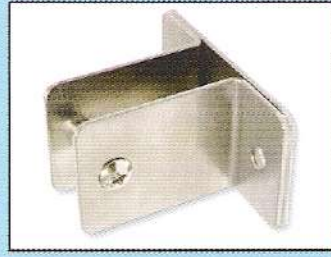
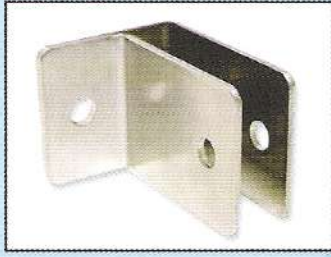

غرف مراوش فينوليك الجاهزة

الأبواب والقواطع والقوائم مصنوعة من الفينوليك سماكة ١٣ ملم كما هو موضح في مواصفات قواطع الحمامات . وتضم حاجز رأسي من عوارض الالمنيوم قطعة واحدة بقطر ٣٢ ملم تثبت على الجدار لتأمين الثبات والقوة مع القوائم وهي ذات قواعد من النوع القابل للتعديل والمثبتة بقوة على الارضية . جميع أدوات التثبيت لكامل غرفة المروش مصنوعة من مواد غير قابله للصدأ .

Door, Divided Panels and Pilasters are made up of 13mm thick solid Phenolic Core as mentioned in the specification of toilet cubicle. A continuous extruded aluminum tube (32mm dia) head rail fixed to the wall provides strength and stability along with Pilasters adjustable leg support strongly fixed to the floor. Non-ferrous hardware have to be furnished for complete cubicle fixing.

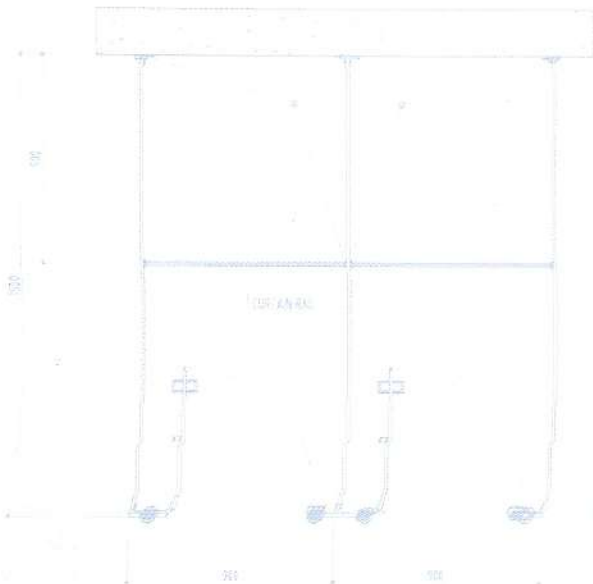

SHOWER CUBICLE





1040 Designer™ Series Plastic Partitions - Laminate Edges 1030 TrimLine™ Series Plastic Laminate Partitions - Stainless Steel Edges



Steel-Core Reinforced Stiles
Durable Plastic Laminate Surfaces
Industrial Grade Particle Board
Concealed Heavy-Duty Hardware
Designer™ Series Delivers Strength Against:

Dents and impacts in heavy-traffic retail, foodservice and industrial washrooms.

Scratching and gouging.

Paint and marker ink. Graffiti cleans without ghosting.

Corrosion and structural failure.

Class B flame spread and smoke development.

Emergency access door keeper.

35 standard colors, see page 7.

1040: Select for commercial, institutional and industrial washrooms where design plus durability are desired. 1030: Install in vandal-prone, institutional, retail and foodservice washrooms.

EASY MAINTENANCE INSTALLATION

Ceiling-Hung configuration facilitates compartment floor cleaning access.

Standard Features



MATERIAL

Doors, stiles and panels: 1" (25mm) finished thickness, 3-ply, 45-lb density resin impregnated particle board construction. 1040: .050" (1mm) thick plastic laminate edges and surfaces. 1030: .050" (1mm) thick, plastic laminate edges and surfaces; laminate routed for flush fit stainless steel edge.



CONCEALED HARDWARE

Heavy-duty, type 304 satin-finish stainless steel for emergency access, door lifts from outside. Hinge can be adjusted for a partial opening or self-closing door; patented, one-piece shoe conceals stile leveling device.

Optional Features



.65 OPTION FULL-HEIGHT HARDWARE

All configurations. Extra-heavy-duty, type 304 satin-finish stainless steel; angle brackets, U-channels and spring loaded, self-closing hinge run full height of panels and doors; for emergency access, door lifts from outside; all fasteners are Pin-Head Torx. Screws; patented, one-piece, shoe conceals stile leveling device. To specify, add .65 suffix to Series Number.



STILE BASE, LEVELING DEVICE

11-gauge steel cone welded to 3/4" x 3/4" (10 x 22mm) steel leveling bar, forming a single structural unit. Finished 3/4" (10mm) diameter, stainless steel wedge floor anchors require minimum 2" (51mm) penetration into minimum 3" (76mm) thick structural concrete floor.



THREADED INSERTS

Threaded inserts are factory installed for securing hinges. Vandal-resistant, Pin-Head Torx Screws for mounting all hardware; saves installation time and expense. T-nuts are factory installed for securing door latch.

T-NUTS



OCCUPANCY INDICATOR DOOR LATCH

Through-the-door stainless steel construction with red-green occupancy indicator, and emergency access feature. Available on special order.

1040 DESIGNER™ SERIES PRODUCT SELECTOR CHART

| Configuration | Standard Series | Optional Feature Full-Height Hardware |
|-----------------|-----------------|---------------------------------------|
| Floor-Anchored | 1041 | 1041.65 |
| Overhead-Braced | 1042 | 1042.65 |
| Ceiling-Hung | 1048 | 1048.65 |

1030 TRIMLINE™ SERIES PRODUCT SELECTOR CHART

| Configuration | Standard Series | Optional Feature Full-Height Hardware |
|-----------------|-----------------|---------------------------------------|
| Floor-Anchored | 1031 | 1031.65 |
| Overhead-Braced | 1032 | 1032.65 |
| Ceiling-Hung | 1038 | 1038.65 |

Configurations Responsive To All Installation Criteria



FLOOR ANCHORED

Recommended for high ceiling washrooms, provides a clean line across top of partitions. Furnished with anchors that require minimum 2" (51mm) penetration into 3" (76mm) thick structural concrete floor. (1041 Floor-Anchored Designer Series shown.)

| DESCRIPTION | SERIES NO. |
|------------------------|------------|
| Stainless Steel Edge | 1038 |
| Laminated Plastic Edge | 1548, 1048 |
| Solid Phenolic | 1088 |

Series: 1081, 1181, 1541, 1041, 1031.



CEILING-HUNG

Provides a clean, open design and easy floor access for maintenance cost savings. Attaches to structural ceiling support furnished by others.

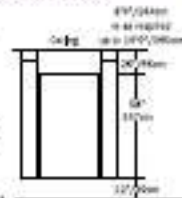

| DESCRIPTION | SERIES NO. |
|------------------------|------------|
| Stainless Steel Edge | 1038 |
| Laminated Plastic Edge | 1548, 1048 |
| Solid Phenolic | 1088 |

Series: 1086, 1186, 1546, 1046, 1036.



OVERHEAD BRACED

Recommended for installations where there are lightweight concrete floors, structural concrete floors less than 3" (76mm) thick or plywood floors. Overhead bracing provides additional rigidity. Furnished with anchors that require minimum 2" (51mm) penetration into 3" (76mm) thick structural concrete floor. (1082 Overhead-Braced DurLine Series pictured.)

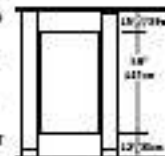

| DESCRIPTION | SERIES NO. |
|------------------------|------------|
| Stainless Steel Edge | 1032 |
| Laminated Plastic Edge | 1542, 1042 |
| Solid Phenolic | 1082 |

Series: 1082, 1182, 1542, 1042, 1032.



MAXIMUM PRIVACY

Compartments with 72" (1830mm) high panels and doors and minimum 4 9/16" (113mm) floor clearance available in all installation configurations. (2031 Maximum Privacy, Floor-Anchored TrimLine Series pictured.)



| DESCRIPTION | SERIES NO. |
|------------------------|------------|
| Stainless Steel Edge | 2030 |
| Laminated Plastic Edge | 2040 |
| Solid Phenolic | 2080 |

To specify Maximum Privacy compartments, select desired Bobrick Series. Then add corresponding suffix to series number to specify desired mounting configuration: "1" for Floor-Anchored or "2" for Overhead-Braced. Example: To designate Maximum Privacy, Overhead-Braced, Designer Series laminated plastic edged compartments, specify Bobrick 2042 Series.



FLOOR-TO-CEILING ANCHORED

Specify for maximum support and vandal-resistance in high-usage washrooms. Requires 3" (76mm) thick structural concrete floor, and structural ceiling support furnished by others. Series: 1086, 1186.

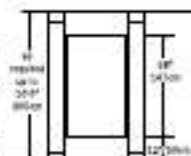

BARRIER-FREE

Recommended for barrier-free access code compliance. Layouts available from Bobrick for Classic, Designer, TrimLine, and DurLine Series. Floor-Anchored and Overhead-Braced installation with either front or side entry. Furnished with black vinyl-coated aluminum handle and an international handicap symbol. (1041 Barrier-Free Floor-Anchored Designer Series pictured.)

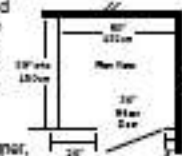

OVERHEAD BRACED

Headrail provides additional support, securing top of stiles to wall. Satin-finish aluminum headrail has raised front edge, anti-grip feature to discourage swinging and chinning. Headrail is end-capped at top and all ends are capped to prevent hiding contraband.

IMPORTANT NOTE

Maximum Privacy Series

In most instances when a single piece of panel is needed in our Maximum Privacy Series the depth of the compartment cannot exceed 60" (1524mm). For panels exceeding 60" (1524mm) in both width and height the following will be supplied.

Solid Phenolic: An "H" Channel is needed between 2 panels. This will be mounted horizontally.

Plastic Laminate: Splicing of the particle board and seaming of the plastic laminate.

